

Ángel Aparicio SPAIN

TECHNICAL LIGHTING
ÉCLAIRAGE TECHNIQUE



Ángel Aparicio SPAIN

TECHNICAL LIGHTING
ÉCLAIRAGE TECHNIQUE







About us

À propos de Nous

Ángel Aparicio Spain was born as a new brand specialized in Technical lighting that belongs to CristalRecord, a Spanish company with more than 20 year of experience in lighting sector.

Our company designs, manufactures and commercializes different types of luminaires made in Spain with LED technology, adapting to the constantly changing need of the global market, as well as creating personalized experiences.

Angel Aparicio est né comme une nouvelle marque spécialisée dans l'éclairage technique qui appartient à Cristalrecord, une entreprise espagnole avec plus de 20 ans d'expérience dans le secteur de l'éclairage.

Notre société dessine, fabrique et commercialise différents types de luminaires fabriqués en Espagne avec une technologie LED, en s'adaptant aux besoins en constante évolution du marché mondial, tout en créant des expériences personnalisées.



Manufacturing Fabrication

.....

Angel Aparicio recessed spotlights and downlight are made of zamak. First it is used the zamak injection mouding, then the ítems are polished and bathed. All the materials used in these processes are of high quality, fact that allows us to offer a guarantee of up to 10 years.

Les spots encastrés et les downlights de Angel Aparicio sont en zamak. On utilise d'abord le moulage par injection de zamak, puis on polit et on baigne les pièces. Tous les matériaux utilisés dans ces processus sont de haute qualité, ce qui nous permet d'offrir une garantie allant jusqu'à 10 ans.

Quality Qualité



As a part of our strong commitment in LED lighting and our efforts in R&D, we have installed our own photometry laboratory equipped with an Ulbricht measuring sphere, with the aim to perform our own products' testing in order to ensure the quality and reliability of our LED lighting solutions.

Testing: Our technicians can test any LED lighting product, of our own or from competitors, quickly and easily, and get a test report including product's key technical parameters.

Dans le cadre de notre engagement fort dans l'éclairage LED et de nos efforts en R&D, nous avons installé notre propre laboratoire de photométrie équipé d'une sphère de mesure Ulbricht, dans le but de réaliser nos propres tests de produits afin de garantir la qualité et la fiabilité de nos solutions d'éclairage LED.

Essais: Nos techniciens peuvent tester n'importe quel produit d'éclairage LED, de notre propre fabrication ou de celle de nos concurrents, rapidement et facilement, et obtenir un rapport de test comprenant les paramètres techniques clés du produit.



CristalRecord works hand-in-hand with external laboratories whose main goals are to provide manufacturers with a mean of ensuring that their products comply with the Directives on Community Safety as well as the speed and reliability of the tests.

CristalRecord travaille tête à tête avec des laboratoires externes dont l'objectif principal est de fournir aux fabricants un moyen de s'assurer que leurs produits respectent les directives sur la sécurité communautaire ainsi que la rapidité et la fiabilité des tests.





Internationalization Internationalisation

.....

Thanks to our excellent Angel Aparicio team, we can answer and satisfy our customer's most demanding expectations anywhere in the world.

Grâce à notre excellente équipe Angel Aparicio, nous pouvons répondre et satisfaire les attentes les plus exigeantes de customers du monde entier.

Values Valeurs

- Innovation • Innovation
- Commitment • Compromis
- Flexibility • Flexibilité
- Quality • Qualité
- Dynamism • Dynamisme
- Efficiency • L' Efficacité
- Adaptability • Adaptabilité
- Proximity • Proximité
- Reliance • Confiance
- Specializations • Spécialisations
- Differentiation • Différenciation





Index Indice

RECESSED SPOTLIGHTS WITHOUT TECHNOLOGY SPOTS ENCASTRÉS SANS TECHNOLOGIE

053100	2
053300	3
353100	4
353300	5
174100	6
174300	7
374100	8
374300	9
491100	10
492100	11
065200	12
055200	13
Living	14
Reto	15
Duo	16
Oneo	16
Apolo	17
Nael	18
Zeus	19
Alhambra	20
Helium	22
Iceberg	26
Aret	28
Snowman	30

RECESSED LED DOWNLIGHTS ENCASTRÉ LED DOWNLIGHTS

25-10W	34
25-13W	35
00-20W	36
00-20W	37
00-28W	37
51-20W	38
51-20W	39
51-28W	39
56-20W	40
Soner	41
Sol	42
Sirion	44
Tekia	45
Know	46

LED SURFACE MOUNTED DOWNLIGHTS LED PLAFONNIERS

Know	50
Ice	54
Dalia	56

LED MIRROR LIGHT
APPLIQUE MIROIR LED

Málaga	61
Álava	62
Zaragoza	63
Sevilla	64
Mallorca	65

LED FLOODLIGHT
PROJECTEUR LED

Luxek	68
Baco	69

LED PANELS
PANNEAUX LED

Led Panel 1 CCT	72
Led Panel 3 CCT	73
Frame Led	74
Eduba	75

LED STRIPS
BANDES LED

Led Strips	78
------------	----

BULBS & REPLACEABLE LED SPOT MODULES
AMPOULES & REMPLACEMENT DES MODULES LED

GU10 6W	82
GU10 8W	83
GU10 9W	84
GU19 6,5W DIMM	85
PACK X2 MR15 5W	86
MR16 7W	87
E14 6W	88
E27 15W	88
Led spot module	90

ACCESSORIES
ACCESSOIRE

Electronic Driver	94
Emergency Kit	96



Ángel Aparicio Spain

**RECESSED SPOTLIGHTS
WITHOUT TECHNOLOGY**

**SPOTS ENCASTRÉS
SANS TECHNOLOGIE**





Serie 053100



Ref. 053100-06

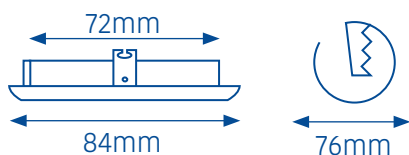

MOVABLE/MATERIAL: ZAMAK INJECTION
FRONT REPLACE BULB

ORIENTABLE/MATIÈRE: ZAMAK INJECTION
REEMPLACER AMPOULE À L'AVANT

Finishes Couleur

- White Blanc **06**
- Gold Doré **08**
- Antic brass Cuir **19**
- Chrome Chrome **22**
- Satin nickel Nickel satiné **42**
- Matt gold Doré mat **68**
- Matt chrome Chrome mat **72**

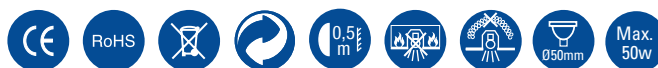

Serie Série	Finish Couleur	Lampholder Douille	Bulb Ampoule	
053100	-	-	No	1/100

Lampholder Douille	Type	IEC Protection Class Classe de protection IEC
-	Without lampholder Sans douille	-
5.3	G5,3 12V	III
GU10	GU10 100-250V	II

Combine them with our bulbs (see pages from 82 to 87)
Combinez-les avec nôtres ampoules (voir pages des 82 à 87)

Serie 053300



MOVABLE/MATERIAL: ZAMAK INJECTION
FRONT REPLACE BULB

ORIENTABLE/MATIÈRE: ZAMAK INJECTION
REEMPLACER AMPOULE À L'AVANT

Finishes Couleur

- 06** White
Blanc
- 08** Gold
Doré
- 19** Antic brass
Cuir
- 22** Chrome
Chrome
- 42** Satin nickel
Nickel satiné
- 68** Matt gold
Doré mat
- 72** Matt chrome
Chrome mat



Ref. 053300-08

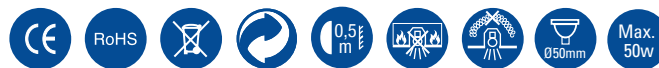
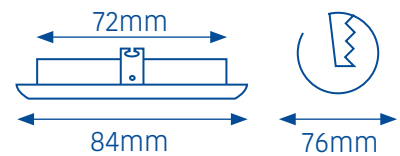

Serie Série	Finish Couleur	Lampholder Douille	Bulb Ampoule	
053300	-	-	No	1/100

Lampholder Douille	Type	IEC Protection Class Classe de protection IEC
-	Without lampholder Sans douille	-
5.3	G5,3 12V	III
GU10	GU10 100-250V	II

Combine them with our bulbs (see pages from 82 to 87)
Combinez-les avec nôtres ampoules (voir pages des 82 à 87)

Serie 353100



Ref. 353100-08

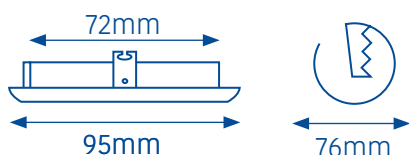

MOVABLE/MATERIAL: ZAMAK INJECTION
FRONT REPLACE BULB

ORIENTABLE/MATIÈRE: ZAMAK INJECTION
REEMPLACER AMPOULE À L'AVANT

Finishes Couleur

- White Blanc **06**
- Gold Doré **08**
- Antic brass Cuir **19**
- Chrome Chrome **22**
- Satin nickel Nickel satiné **42**
- Matt gold Doré mat **68**
- Matt chrome Chrome mat **72**



Serie Série	Finish Couleur	Lampholder Douille	Bulb Ampoule	
353100	-	-	No	1/100

Lampholder Douille	Type	IEC Protection Class Classe de protection IEC
-	Without lampholder Sans douille	-
5.3	G5,3 12V	III
GU10	GU10 100-250V	II

Combine them with our bulbs (see pages from 82 to 87)
Combinez-les avec nôtres ampoules (voir pages des 82 à 87)

Serie 353300



MOVABLE/MATERIAL: ZAMAK INJECTION
FRONT REPLACE BULB

ORIENTABLE/MATIÈRE: ZAMAK INJECTION
REEMPLACER AMPOULE À L'AVANT



Ref. 353300-06

Finishes Couleur

- 06** White
Blanc
- 08** Gold
Doré
- 19** Antic brass
Cuir
- 22** Chrome
Chrome
- 42** Satin nickel
Nickel satiné
- 68** Matt gold
Doré mat
- 72** Matt chrome
Chrome mat

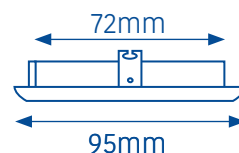

Serie Série	Finish Couleur	Lampholder Douille	Bulb Ampoule	
353300	-	-	No	1/100

Lampholder Douille	Type	IEC Protection Class Classe de protection IEC
-	Without lampholder Sans douille	-
5.3	G5,3 12V	III
GU10	GU10 100-250V	II

Combine them with our bulbs (see pages from 82 to 87)
Combinez-les avec nôtres ampoules (voir pages des 82 à 87)

Serie 174100



Ref. 174100-06



MOVABLE/MATERIAL: ZAMAK INJECTION
FRONT REPLACE BULB

ORIENTABLE/MATIÈRE: ZAMAK INJECTION
REEMPLACER AMPOULE À L'AVANT

Finishes Couleur

- White Blanc **06**
- Gold Doré **08**
- Antic brass Cuir **19**
- Chrome Chrome **22**
- Satin nickel Nickel satiné **42**
- Matt gold Doré mat **68**
- Matt chrome Chrome mat **72**

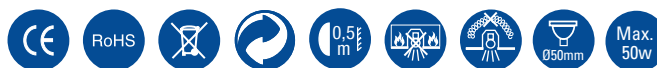
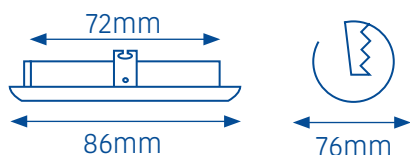

Serie Série	Finish Couleur	Lampholder Douille	Bulb Ampoule	
174100	-	-	No	1/100

Lampholder Douille	Type	IEC Protection Class Classe de protection IEC
-	Without lampholder Sans douille	-
5.3	G5,3 12V	III
GU10	GU10 100-250V	II

Combine them with our bulbs (see pages from 82 to 87)
Combinez-les avec nôtres ampoules (voir pages des 82 à 87)

Serie 174300



MOVABLE/MATERIAL: ZAMAK INJECTION
FRONT REPLACE BULB

ORIENTABLE/MATIÈRE: ZAMAK INJECTION
REEMPLACER AMPOULE À L'AVANT



Ref. 174300-06

Finishes Couleur

- 06** White
Blanc
- 08** Gold
Doré
- 19** Antic brass
Cuir
- 22** Chrome
Chrome
- 42** Satin nickel
Nickel satiné
- 68** Matt gold
Doré mat
- 72** Matt chrome
Chrome mat

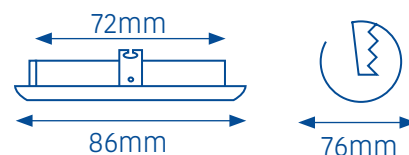

Serie Série	Finish Couleur	Lampholder Douille	Bulb Ampoule	
174300	-	-	No	1/100

Lampholder Douille	Type	IEC Protection Class Classe de protection IEC
-	Without lampholder Sans douille	-
5.3	G5,3 12V	III
GU10	GU10 100-250V	II

Combine them with our bulbs (see pages from 82 to 87)
Combinez-les avec nôtres ampoules (voir pages des 82 à 87)

Serie 374100



Ref. 374100-19

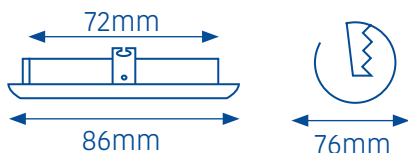

MOVABLE/MATERIAL: ZAMAK INJECTION
FRONT REPLACE BULB

ORIENTABLE/MATIÈRE: ZAMAK INJECTION
REEMPLACER AMPOULE À L'AVANT

Finishes Couleur

- White Blanc **06**
- Gold Doré **08**
- Antic brass Cuir **19**
- Chrome Chrome **22**
- Satin nickel Nickel satiné **42**
- Matt gold Doré mat **68**
- Matt chrome Chrome mat **72**



Serie Série	Finish Couleur	Lampholder Douille	Bulb Ampoule	
374100	-	-	No	1/100

Lampholder Douille	Type	IEC Protection Class Classe de protection IEC
-	Without lampholder Sans douille	-
5.3	G5,3 12V	III
GU10	GU10 100-250V	II

Combine them with our bulbs (see pages from 82 to 87)
Combinez-les avec nôtres ampoules (voir pages des 82 à 87)

Serie 374300



MOVABLE/MATERIAL: ZAMAK INJECTION
FRONT REPLACE BULB

ORIENTABLE/MATIÈRE: ZAMAK INJECTION
REEMPLACER AMPOULE À L'AVANT

Finishes Couleur

- 06** White
Blanc
- 08** Gold
Doré
- 19** Antic brass
Cuir
- 22** Chrome
Chrome
- 42** Satin nickel
Nickel satiné
- 68** Matt gold
Doré mat
- 72** Matt chrome
Chrome mat



Ref. 374300-42

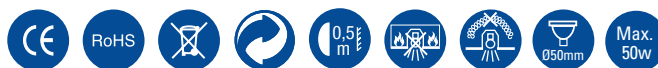
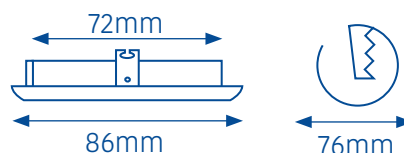

Serie Série	Finish Couleur	Lampholder Douille	Bulb Ampoule	
374300	- <input type="checkbox"/>	- <input type="checkbox"/>	No	1/100

Lampholder Douille	Type	IEC Protection Class Classe de protection IEC
-	Without lampholder Sans douille	-
5.3	G5,3 12V	III
GU10	GU10 100-250V	II

Combine them with our bulbs (see pages from 82 to 87)
Combinez-les avec nôtres ampoules (voir pages des 82 à 87)

Serie 491100



Ref. 491100-06



FIXED/MATERIAL: ZAMAK INJECTION
FRONT REPLACE BULB

FIXE/MATIÈRE: ZAMAK INJECTION
REPLACER AMPOULE À L'AVANT

Finishes
Couleur

White
Blanc **06**

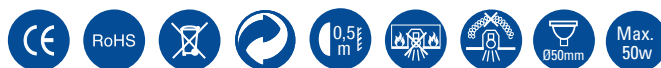
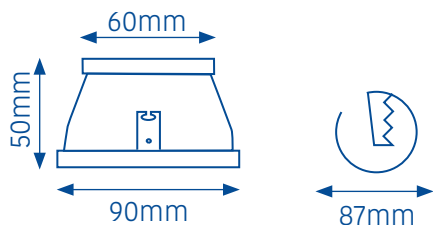

Serie Série	Finish Couleur	Lampholder Douille	Bulb Ampoule	
491100	- 06	- 	No	1/75

Lampholder Douille	Type	IEC Protection Class Classe de protection IEC
-	Without lampholder Sans douille	-
5.3	G5,3 12V	III
GU10	GU10 100-250V	II

Combine them with our bulbs (see pages from 82 to 87)
and with our LED modules (see pages 90 & 91)
Combinez-les avec nôtres ampoules (voir pages des 82 à 87)
et avec nôtres modules LED (voir pages 90 & 91)

Serie 492100



FIXED/MATERIAL: ZAMAK INJECTION
FRONT REPLACE BULB

FIXE/MATIÈRE: ZAMAK INJECTION
REEMPLACER AMPOULE À L'AVANT

Finishes Couleur

06 White
Blanc



Ref. 492100-06

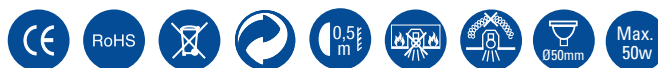
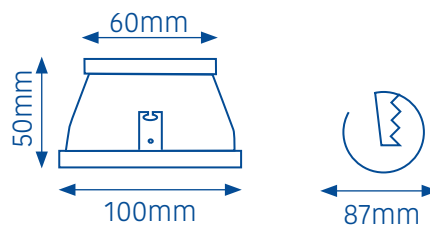

Serie Série	Finish Couleur	Lampholder Douille	Bulb Ampoule	
492100	- 06	-	No	1/75

Lampholder Douille	Type	IEC Protection Class Classe de protection IEC
-	Without lampholder Sans douille	-
5.3	G5,3 12V	III
GU10	GU10 100-250V	II

Combine them with our bulbs (see pages from 82 to 87)
and with our LED modules (see pages 90 & 91)
Combinez-les avec nôtres ampoules (voir pages des 82 à 87)
et avec nôtres modules LED (voir pages 90 & 91)

Serie 065200



Ref. 065200-42

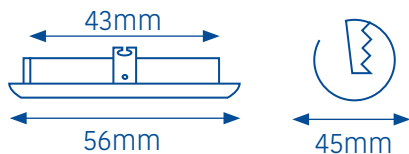

FIXED/MATERIAL: ZAMAK INJECTION
FRONT REPLACE BULB

FIXE/MATIÈRE: ZAMAK INJECTION
REPLACER AMPOULE À L'AVANT

Finishes Couleur

- White Blanc **06**
- Gold Doré **08**
- Antic brass Cuir **19**
- Chrome Chrome **22**
- Satin nickel Nickel satiné **42**
- Matt gold Doré mat **68**
- Matt chrome Chrome mat **72**



Serie Série	Finish Couleur	Lampholder Douille	Bulb Ampoule	
065200	-	-	No	1/100

Lampholder Douille	Type	IEC Protection Class Classe de protection IEC
-	Without lampholder Sans douille	-
5.3	G5,3 12V	III
GU10	GU10 100-250V	II

Serie 055200



FIXED/MATERIAL: ZAMAK INJECTION
FRONT REPLACE BULB

FIXE/MATIÈRE: ZAMAK INJECTION
REEMPLACER AMPOULE À L'AVANT



Ref. 055220-19

Finishes Couleur

- 06** White
Blanc
- 08** Gold
Doré
- 19** Antic brass
Cuir
- 22** Chrome
Chrome
- 42** Satin nickel
Nickel satiné
- 68** Matt gold
Doré mat
- 72** Matt chrome
Chrome mat

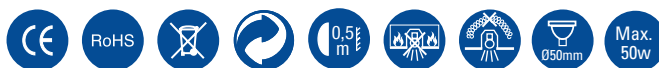
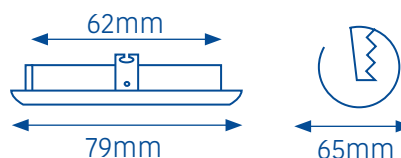

Serie Série	Finish Couleur	Lampholder Douille	Bulb Ampoule	
055200	-	-	No	1/100

Lampholder Douille	Type	IEC Protection Class Classe de protection IEC
-	Without lampholder Sans douille	-
5.3	G5,3 12V	III
GU10	GU10 100-250V	II

Combine them with our bulbs (see pages from 82 to 87)
and with our LED modules (see pages 90 & 91)
Combinez-les avec nôtres ampoules (voir pages des 82 à 87)
et avec nôtres modules LED (voir pages 90 & 91)

Living



Ref. 01-076-01-000



Ref. 00-176-01-281



Ref. 01-076-01-008



FIXED/MATERIAL: ALUMINIUM
BACK REPLACE BULB

FIXE/MATIÈRE: ALUMINIUM
REMPLEUR AMPOULE À LE DERRIÈRE

Finishes Couleur

Sand White
Blanc texturé **000**

White
Blanc **200**

Black
Noir **008**

Silver
Argenté **281**

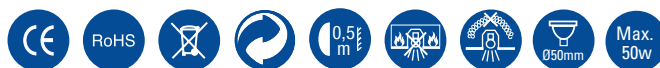
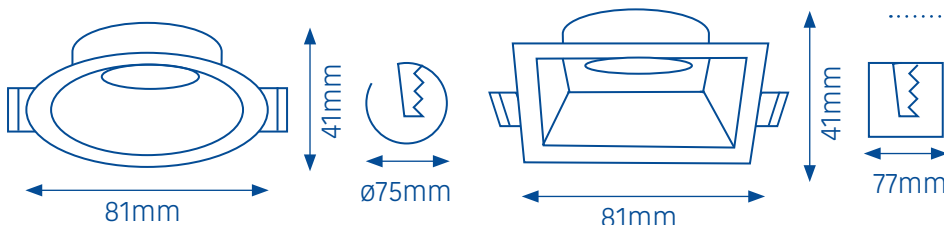

Serie Série	Finish Couleur	Lampholder Douille	Shape Forme	Bulb Ampoule	
01-076-01	-	-	Round/Rond	No	1/40
00-176-01	-	-	Square/Carré	No	1/40

Lampholder
Douille

Type

IEC Protection Class
Classe de protection IEC

-	Without lampholder Sans douille	-
5.3	G5,3 12V	III
GU10	GU10 100-250V	II

Combine them with our bulbs (see pages from 82 to 87)
and with our LED modules (see pages 90 & 91)
Combinez-les avec nôtres ampoules (voir pages des 82 à 87)
et avec nôtres modules LED (voir pages 90 & 91)

Reto



FIXED/MATERIAL: ALUMINIUM
BACK REPLACE BULB

FIXE/MATIÈRE: ALUMINIUM
REMPLENER AMPOULE À LE DERRIÈRE

Finishes Couleur

- 000** White
Blanc
- 008** Black
Noir



Ref. 01-047-01-000

Ref. 01-047-01-008

Ref. 01-047-01-000

Ref. 01-047-01-008

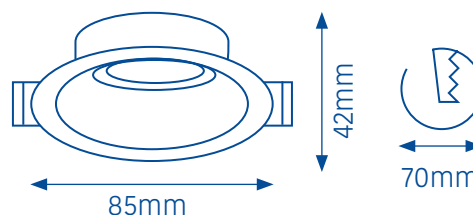

- 000** White
Blanc
- 008** Black
Noir
- 001** Chrome
Chrome
- 002** Nickel
Nickel



Serie Série	Finish Couleur	Lampholder Douille	IP	Bulb Ampoule	
01-047-01	<input type="checkbox"/>	<input type="checkbox"/>	23	No	1/40
01-047-44	<input type="checkbox"/>	<input type="checkbox"/>	44	No	1/40

** MOQ for 01-047-44, 500 pieces.

Serie Série	Finish Couleur	Material Matiré	
ARO-047	<input type="checkbox"/>	Aluminium/Aluminium	1/160



Lampholder Douille	Type	IEC Protection Class Classe de protection IEC
-	Without lampholder Sans douille	-
5.3	G5,3 12V	III
GU10	GU10 100-250V	II

Combine them with our bulbs (see pages from 82 to 87)
Combinez-les avec nôtres ampoules (voir pages des 82 à 87)



Ref. 01-853-00-100

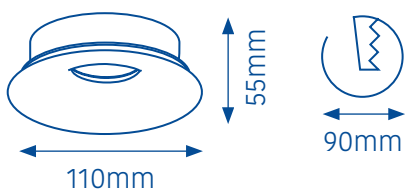

Ref. 01-953-00-100

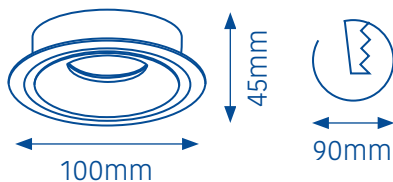

Duo/Oneo



FIXED/MATERIAL: ALUMINIUM
BACK REPLACE BULB

FIXE/MATIÈRE: ALUMINIUM
REMPLENER AMPOULE À LE DERRIÈRE

Finishes
Couleur

White
Blanc **100**

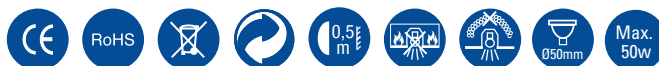

Serie Série	Finish Couleur	Lampholder Douille	Bulb Ampoule	
01-853-00	- 100	-	No	1/40
01-953-00	- 100	-	No	1/40

Lampholder Douille	Type	IEC Protection Class Classe de protection IEC
-	Without lampholder Sans douille	-
5.3	G5,3 12V	III
GU10	GU10 100-250V	II

Combine them with our bulbs (see pages from 82 to 87)
and with our LED modules (see pages 90 & 91)
Combinez-les avec nôtres ampoules (voir pages des 82 à 87)
et avec nôtres modules LED (voir pages 90 & 91)

Apolo



MOVABLE/MATERIAL: ALUMINIUM
FRONT REPLACE BULB

ORIENTABLE/MATIÈRE: ALUMINIUM
REEMPLACER AMPOULE À L'AVANT

Finishes Couleur

000 White
Blanc



Ref. 01-593-01-000

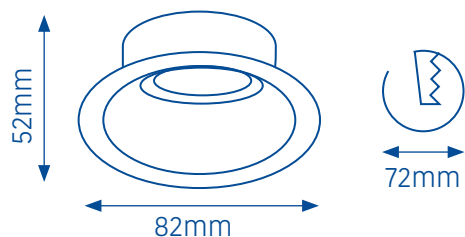

Ref. 00-593-01-000

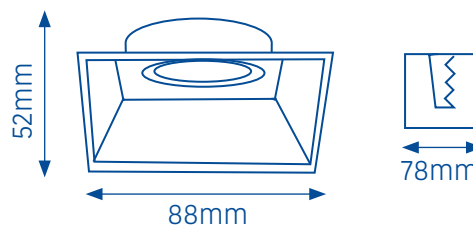

Serie Série	Finish Couleur	Lampholder Douille	Shape Forme	Bulb Ampoule	
01-593-01	- 000	-	Round/Rond	No	1/100
00-593-01	- 000	-	Square/Carré	No	1/100

Lampholder Douille	Type	IEC Protection Class Classe de protection IEC
-	Without lampholder Sans douille	-
5.3	G5,3 12V	III
GU10	GU10 100-250V	II

Combine them with our bulbs (see pages from 82 to 87)
and with our LED modules (see pages 90 & 91)
Combinez-les avec nôtres ampoules (voir pages des 82 à 87)
et avec nôtres modules LED (voir pages 90 & 91)

Nael



Ref. 01-893-01-000



Ref. 00-893-01-000



FIXED/MATERIAL: ALUMINIUM
FRONT REPLACE BULB

FIXE/MATIÈRE: ALUMINIUM
REEMPLACER AMPOULE À L'AVANT

Finishes
Couleur

White
Blanc **000**

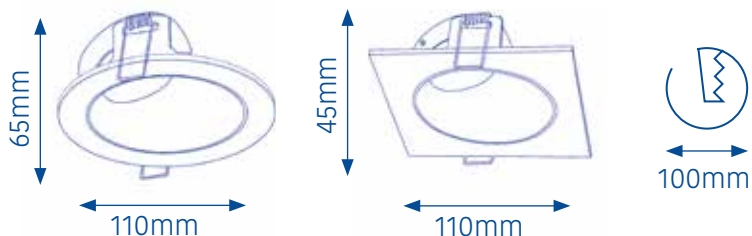

Serie Série	Finish Couleur	Lampholder Douille	Shape Forme	Bulb Ampoule	
01-893-01	- 000	-	Round/Rond	No	1/50
00-893-01	- 000	-	Square/Carré	No	1/50

Lampholder Douille	Type	IEC Protection Class Classe de protection IEC
-	Without lampholder Sans douille	-
5.3	G5,3 12V	III
GU10	GU10 100-250V	II

Combine them with our bulbs (see pages from 82 to 87)
Combinez-les avec nôtres ampoules (voir pages des 82 à 87)

Zeus



FIXED/MATERIAL: ALUMINIUM
BACK REPLACE BULB

FIXE/MATIÈRE: ALUMINIUM
REMPLENER AMPOULE À LE DERRIÈRE



Ref. 01-493-01-000



Ref. 00-493-01-000

Finishes Couleur

000 White
Blanc

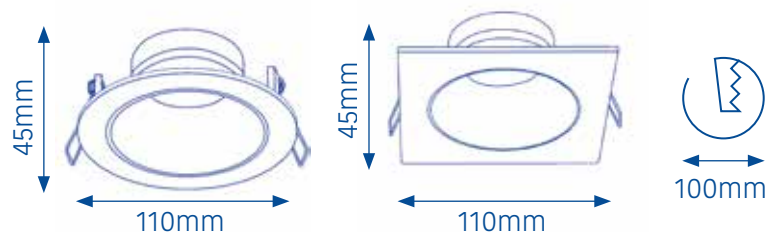

Serie Série	Finish Couleur	Lampholder Douille	Shape Forme	Bulb Ampoule	
01-493-01	- 000	-	Round/Rond	No	1/50
00-493-01	- 000	-	Square/Carré	No	1/50

Lampholder Douille	Type	IEC Protection Class Classe de protection IEC
-	Without lampholder Sans douille	-
5.3	G5,3 12V	III
GU10	GU10 100-250V	II

Combine them with our bulbs (see pages from 82 to 87)
and with our LED modules (see pages 90 & 91)
Combinez-les avec nôtres ampoules (voir pages des 82 à 87)
et avec nôtres modules LED (voir pages 90 & 91)



Ref. 01-302-01-000



Ref. 00-302-01-000

Alhambra



FIXED/MATERIAL: CAST ALUMINIUM
FRONT REPLACE BULB

FIXE /MATIÈRE: FONDU ALUMINIUM
REEMPLACER AMPOULE À L'AVANT

Finishes
Couleur

White
Blanc **000**

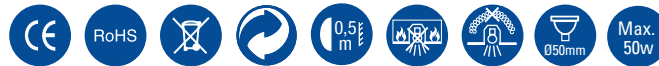
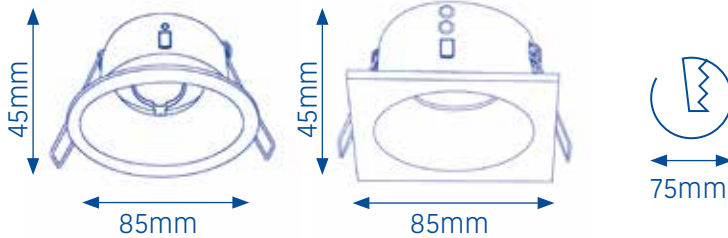

Serie Série	Finish Couleur	Lampholder Douille	Shape Forme	Bulb Ampoule	
01-302-01	- 000	-	Round/Rond	No	1/80
00-302-01	- 000	-	Square/Carré	No	1/80

Lampholder Douille	Type	IEC Protection Class Classe de protection IEC
-	Without lampholder Sans douille	-
5.3	G5,3 12V	III
GU10	GU10 100-250V	II

Combine them with our bulbs (see pages from 82 to 87)
and with our LED modules (see pages 90 & 91)
Combinez-les avec nôtres ampoules (voir pages des 82 à 87)
et avec nôtres modules LED (voir pages 90 & 91)

Alhambra



FIXED/MATERIAL: CAST ALUMINIUM
FRONT REPLACE BULB

FIXE /MATIÈRE: FONDU ALUMINIUM
REEMPLACER AMPOULE À L'AVANT



Ref. 01-402-01-888



Ref. AR-402-01-000



Ref. AR-402-00-002

Finishes Couleur

000 White
Blanc

002 Nickel
Nickel

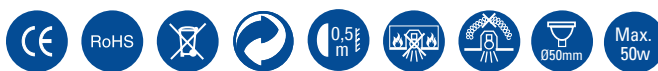
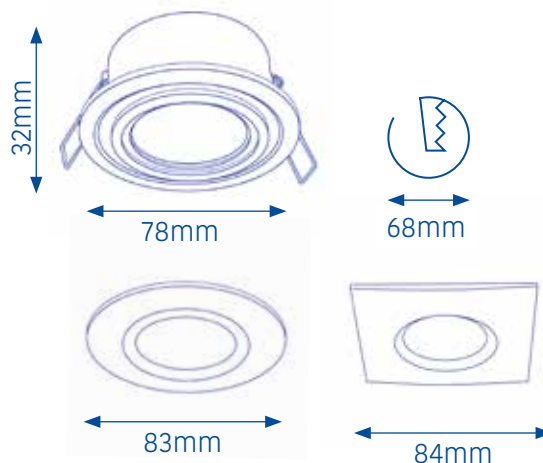

Serie Série	Finish Couleur	Lampholder Douille	Bulb Ampoule	
01-402-01	- 888	-	No	1/100

Lampholder Douille	Type	IEC Protection Class Classe de protection IEC	DECORATIVE BEZELS MONTURES DÉCORATIVES				
			Serie Série	Finish Couleur	Material Matiré	Shape Forme	
-	Without lampholder Sans douille	-	AR-402-01	-	Aluminium/Aluminium	Round/Rond	1/200
5.3	G5,3 12V	III	AR-402-00	-	Aluminium/Aluminium	Square/Carré	1/200
GU10	GU10 100-250V	II					

Combine them with our bulbs (see pages from 82 to 87)
and with our LED modules (see pages 90 & 91)
Combinez-les avec nôtres ampoules (voir pages des 82 à 87)
et avec nôtres modules LED (voir pages 90 & 91)

Helium



Ref. 01-010-00-003



Ref. 01-010-00-000



MOVABLE/ MATERIAL: ALUMINIUM
FRONT REPLACE BULB

ORIENTABLE /MATIÈRE: ALUMINIUM
REEMPLACER AMPOULE À L'AVANT



Ref. 01-010-00-115



Ref. 01-010-80-180



Ref. 01-010-00-006

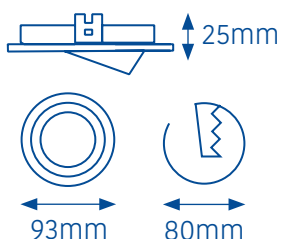

Lampholder Douille	Type	IEC Protection Class Classe de protection IEC
-	Without lampholder Sans douille	-
5.3	G5,3 12V	III
GU10	GU10 100-250V	II



Serie Série	Lampholder Douille	Finish Couleur	Bulb Ampoule	
01-010-00-000	-	White/Blanc	No	1/100
01-010-00-003	-	Inox/Inox	No	1/100
01-010-00-115	-	Inox/Wengue Inox/Wengue	No	1/100
01-010-80-180	-	Black/Noir	No	1/100
01-010-00-006	-	Antic Brass/Cuir	No	1/100

Combine them with our bulbs (see pages from 82 to 87) and with our LED modules (see pages 90 & 91)
Combinez-les avec nôtres ampoules (voir pages des 82 à 87) et avec nôtres modules LED (voir pages 90 & 91)

Helium



MOVABLE/ MATERIAL: ALUMINIUM
FRONT REPLACE BULB

ORIENTABLE /MATIÈRE: ALUMINIUM
REMPLENER AMPOULE À L'AVANT

Lampholder Douille	Type	IEC Protection Class Classe de protection IEC
-	Without lampholder Sans douille	-
5.3	G5,3 12V	III
GU10	GU10 100-250V	II

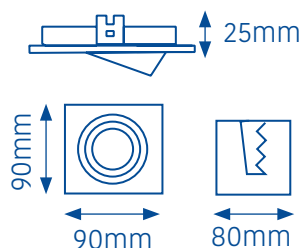

Ref. 03-060-00-000



Ref. 03-061-00-003



Ref. 03-061-00-000

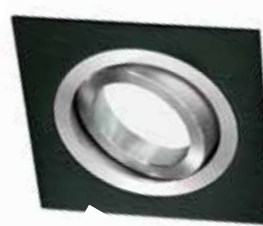

Ref. 03-061-00-115



Ref. 03-061-80-180

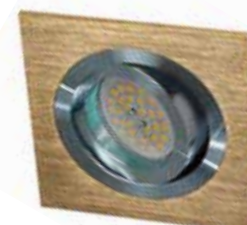

Ref. 03-061-00-007



Ref. 03-061-00-006



Serie Série	Lampholder Douille	Finish Couleur	Bulb Ampoule	
03-060-00-000	-	White/Blanc	No	1/100
03-061-00-000	-	Inox/Shiny White Inox/Blanc Lumineux	No	1/100
03-061-00-003	-	Inox/Inox	No	1/100
03-061-00-006	-	Antic Brass/Cuir	No	1/100
03-061-00-007	-	Inox/Anodised Copper Inox/Cuivre Anodisé	No	1/100
03-061-00-115	-	Inox/Wengue/Inox/Wengue	No	1/100
03-061-80-180	-	Black/Noir	No	1/100

Combine them with our bulbs (see pages from 82 to 87) and with our LED modules (see pages 90 & 91)
Combinez-les avec nôtres ampoules (voir pages des 82 à 87) et avec nôtres modules LED (voir pages 90 & 91)

Helium



Ref. 03-062-00-003



MOVABLE/ MATERIAL: ALUMINIUM
FRONT REPLACE BULB

ORIENTABLE /MATIÈRE: ALUMINIUM
REEMPLACER AMPOULE À L'AVANT



Ref. 03-063-00-115

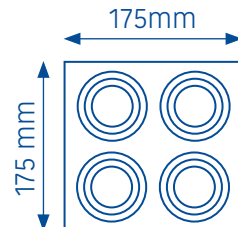
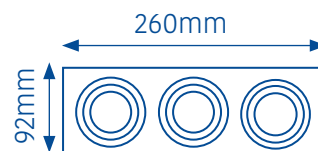
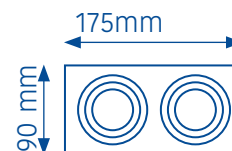

Ref. 03-064-00-115

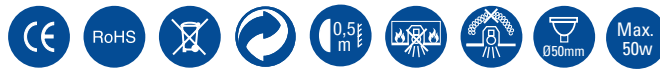

Serie Série	Lampholder Douille	Finish Couleur	No. Lights no. Lumières	Bulb Ampoule	
03-062-00-003	-	Inox/Inox	2	No	1/30
03-062-00-115	-	Inox/Wengue Inox/Wengue	2	No	1/30
03-063-00-003	-	Inox/Inox	3	No	1/20
03-063-00-115	-	Inox/Wengue Inox/Wengue	3	No	1/20
03-064-00-003	-	Inox/Inox	4	No	1/30
03-064-00-115	-	Inox/Wengue Inox/Wengue	4	No	1/30

Lampholder Douille	Type	IEC Protection Class Classe de protection IEC
-	Without lampholder Sans douille	-
5.3	G5,3 12V	III
GU10	GU10 100-250V	II

Combine them with our bulbs (see pages from 82 to 87) and with our LED modules (see pages 90 & 91)
Combinez-les avec nôtres ampoules (voir pages des 82 à 87) et avec nôtres modules LED (voir pages 90 & 91)



MOVABLE/ MATERIAL: ALUMINIUM AND ACRYLIC RING
FRONT REPLACE BULB

ORIENTABLE /MATIÈRE: ALUMINIUM ET
REPLACER AMPOULE À L'AVANT

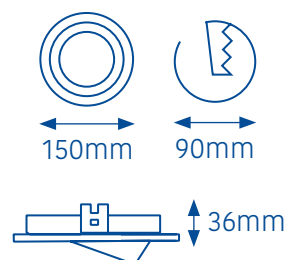

Ref. 01-010-03-100



Serie Série	Shape Forme	Finish Couleur	W	K	Lm	Lampholder Doville	Bulb Ampoule	Class Classe
01-010-03-100	Round/Rond	Aluminium	2,4	6000	150	GU10&G5.3	No	II/III
01-010-15-100	Round/Rond	Black/Noir	2,4	6000	150	GU10&G5.3	No	II/III
01-010-00-100	Round/Rond	White/Blanc	2,4	6000	150	GU10&G5.3	No	II/III
01-010-03-120	Round/Rond	Aluminium	2,4	Blue Led	150	GU10&G5.3	No	II/III
01-010-15-120	Round/Rond	Black/Noir	2,4	Blue Led	150	GU10&G5.3	No	II/III
01-010-00-120	Round/Rond	White/Blanc	2,4	Blue Led	150	GU10&G5.3	No	II/III
01-310-03-100	Round/Rond	Aluminium	2,4	3000	150	GU10&G5.3	No	II/III
01-310-15-100	Round/Rond	Black/Noir	2,4	3000	150	GU10&G5.3	No	II/III
01-310-00-100	Round/Rond	White/Blanc	2,4	3000	150	GU10&G5.3	No	II/III

Combine them with our bulbs (see pages from 82 to 87)
Combinez-les avec nôtres ampoules (voir pages des 82 à 87)



Ref. 00-061-03-100

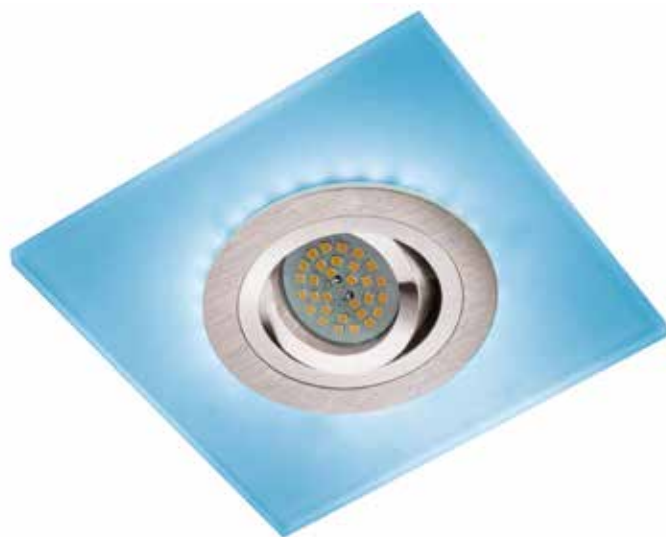

Ref. 00-010-03-120

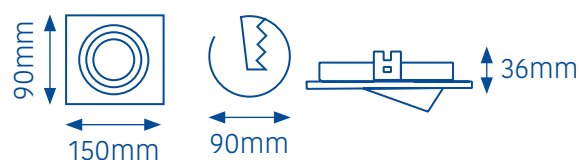

Serie Série	Shape Forme	Finish Couleur	W	K	Lm	Lampholder Doville	Bulb Ampoule	Class Classe
00-061-03-100	Square/Carré	Aluminium	2,4	6000	150	GU10&G5.3	No	II/III
00-061-15-100	Square/Carré	Black/Noir	2,4	6000	150	GU10&G5.3	No	II/III
00-061-00-100	Square/Carré	White/Blanc	2,4	6000	150	GU10&G5.3	No	II/III
00-061-03-120	Square/Carré	Aluminium	2,4	Blue Led	150	GU10&G5.3	No	II/III
00-061-15-120	Square/Carré	Black/Noir	2,4	Blue Led	150	GU10&G5.3	No	II/III
00-061-00-120	Square/Carré	White/Blanc	2,4	Blue Led	150	GU10&G5.3	No	II/III
00-361-03-100	Square/Carré	Aluminium	2,4	3000	150	GU10&G5.3	No	II/III
00-361-15-100	Square/Carré	Black/Noir	2,4	3000	150	GU10&G5.3	No	II/III
00-361-00-100	Square/Carré	White/Blanc	2,4	3000	150	GU10&G5.3	No	II/III
00-010-03-100	Round/Rond	Aluminium	2,4	6000	150	GU10&G5.3	No	II/III
00-010-15-100	Round/Rond	Black/Noir	2,4	6000	150	GU10&G5.3	No	II/III
00-010-00-100	Round/Rond	White/Blanc	2,4	6000	150	GU10&G5.3	No	II/III
00-010-03-120	Round/Rond	Aluminium	2,4	Blue Led	150	GU10&G5.3	No	II/III
00-010-15-120	Round/Rond	Black/Noir	2,4	Blue Led	150	GU10&G5.3	No	II/III
00-010-00-120	Round/Rond	White/Blanc	2,4	Blue Led	150	GU10&G5.3	No	II/III
00-310-03-100	Round/Rond	Aluminium	2,4	3000	150	GU10&G5.3	No	II/III
00-310-15-100	Round/Rond	Black/Noir	2,4	3000	150	GU10&G5.3	No	II/III
00-310-00-100	Round/Rond	White/Blanc	2,4	3000	150	GU10&G5.3	No	II/III



MOVABLE/MATERIAL: ZAMAK INJECTION
FRONT REPLACE BULB

ORIENTABLE/MATIÈRE: ZAMAK INJECTION
REEMPLACER AMPOULE À L'AVANT

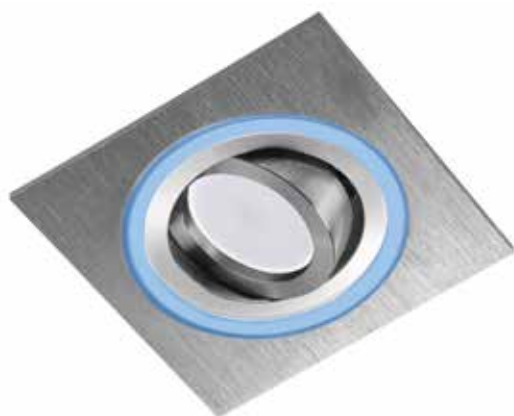

Ref. 01-170-03-120



Ref. 01-070-03-100

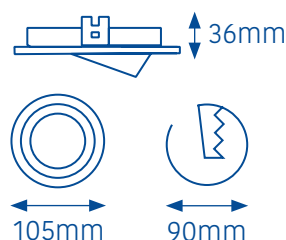
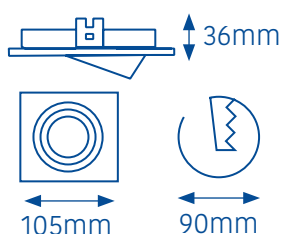

Serie Série	Shape Forme	W	K	Lm	Lampholder Douille	Bulb Ampoule	Class Classe
01-070-03-100	Round/Rond	2,4	6000	150	GU10&G5.3	No	II/III
01-070-03-120	Round/Rond	2,4	Blue Led	150	GU10&G5.3	No	II/III
01-071-03-100	Round/Rond	2,4	3000	150	GU10&G5.3	No	II/III
00-170-03-100	Square/Carré	2,4	6000	150	GU10&G5.3	No	II/III
00-170-03-120	Square/Carré	2,4	Blue Led	150	GU10&G5.3	No	II/III
00-171-03-100	Square/Carré	2,4	3000	150	GU10&G5.3	No	II/III

Combine them with our bulbs (see pages from 82 to 87) and with our LED modules (see pages 90 & 91)
Combinez-les avec nôtres ampoules (voir pages des 82 à 87) et avec nôtres modules LED (voir pages 90 & 91)



Snowman



MOVABLE/MATERIAL: ZAMAK INJECTION
FRONT REPLACE BULB

ORIENTABLE/MATIÈRE: ZAMAK INJECTION
REPLACER AMPOULE À L'AVANT



Ref. 01-404-00-100

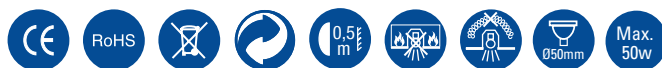
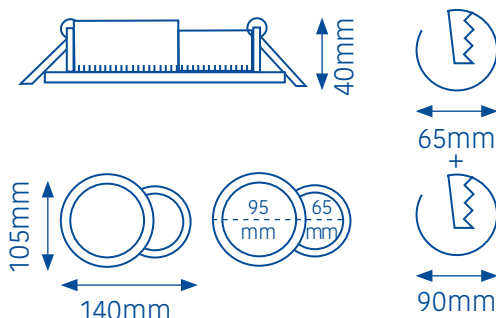

Serie Série	Shape Forme	W	K	Lm	Lampholder Douille	Bulb Ampoule	Class Classe	Driver
01-404-00-100	Round/Rond	3	6000	240	GU10&G5.3	No	II/III	Eaglerise
01-404-00-181	Round/Rond	3	6000	240	GU10&G5.3	No	II/III	Eaglerise
01-484-00-100	Round/Rond	3	3000	240	GU10&G5.3	No	II/III	Eaglerise
01-484-00-181	Round/Rond	3	3000	240	GU10&G5.3	No	II/III	Eaglerise

Combine them with our bulbs (see pages from 82 to 87)
Combinez-les avec nôtres ampoules (voir pages des 82 à 87)





A modern living room interior featuring a white ceiling with several recessed LED downlights. The room includes a white and dark wood modular shelving unit, a white and black armchair, a round coffee table, and a large window overlooking a cityscape. The floor is dark wood, and there is a light-colored rug.

Ángel Aparicio Spain

RECESSED LED DOWNLIGHTS
ENCASTRÉ LED DOWNLIGHTS



Serie 25-10W



MATERIAL: ZAMAK AND ACRYLIC.

MATIÈRE: ZAMAK ET ACRYLIQUE

Finishes Couleur

- White Blanc **06**
- Satin nickel Nickel satiné **42**
- Matt chrome Chrome mat **72**

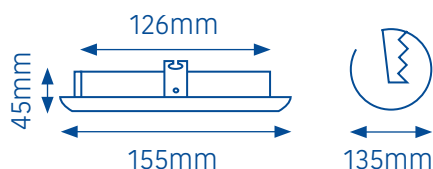

K	TC (K)	Chip lm
621	3000	900 (90 lm/W)
620	4000	1000 (100 lm/W)
626	6000	1100 (110 lm/W)

Driver	Driver Brand	Dimm	Guarantee	PF
-	AA SPAIN	NO	5	>0,9
TCI	TCI	NO	7	> 0,95
DIMM	TCI	1-10V/PUSH	7	> 0,95
DALI	TCI	DALI	7	> 0,92



LED CHIP: EPISTAR SMD 5630 ; CRI > 80 / 36,000 hours ; 3 YEARS GUARANTEE

Serie	K	Finish	Driver	W	V	Hz	o	
L25110	<input type="checkbox"/>	-	<input type="checkbox"/>	10	220-240	50/60	120	1/24

ACCESORIES/ACCESSOIRES PAG 93
EMERGENCY KIT

Ref. Brand Hour / Heure

KE-1H-7W-TCI	TCI	1
KE-3H-7W-TCI	TCI	3

Serie 25-13W



MATERIAL: ZAMAK AND ACRYLIC.

MATIÈRE: ZAMAK ET ACRYLIQUE



Finishes Couleur

- 06** White
Blanc
- 42** Satin nickel
Nickel satiné
- 72** Matt chrome
Chrome mat

K	TC (K)	Chip lm
621	3000	1650 (127 lm/W)
620	4000	1730 (133 lm/W)
625	5000	1780 (137 lm/W)

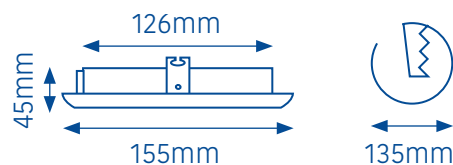

Driver	Driver Brand	Dimm	Guarantee	PF
TCI-HP	TCI	NO	10	>0,95
TCI-HPD	TCI	1-10V/PUSH	10	>0,95
HP-DALI	TCI	DALI	10	>0,92



LED CHIP: SAMSUNG SMD 5630 CRI > 80 - L80/B20 80.000 hours ; 3SDCM; 10 YEARS GUARANTEE

Serie	K	Finish	Driver	W	V	Hz	o	
L25113	<input type="checkbox"/>	-	<input type="checkbox"/>	13	220-240	50/60	120	1/24

ACCESORIES/ACCESSOIRES PAG 93
EMERGENCY KIT

Ref.	Brand	Hour / Heure
KE-1H-7W-TCI	TCI	1
KE-3H-7W-TCI	TCI	3

Serie 00-20W



MATERIAL: ZAMAK AND ACRYLIC.

MATIÈRE: ZAMAK ET ACRYLIQUE

Finishes Couleur

White Blanc	06	Satin nickel Nickel satiné	42
Gold Doré	08	Matt gold Doré mat	68
Antic Brass Cuir	19	Matt chrome Chrome mat	72
Chrome Chrome	22		

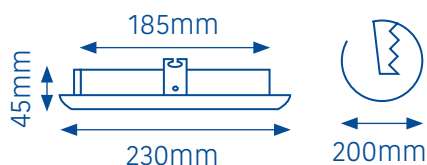

K	TC (K)	Chip lm
621	3000	2100 (105 lm/W)
620	4000	2200 (110 lm/W)
626	6000	2300 (115 lm/W)

Driver	Driver Brand	Dimm	Guarantee	PF
-	A.A. SPAIN	NO	5	>0,9
TCI	TCI	NO	7	>0,95
DIMM	TCI	1-10V/PUSH	7	>0,95
DALI	TCI	DALI	7	>0,92



LED CHIP: EPISTAR SMD 5630 ; CRI > 80 / 36,000 hours ; 3 YEARS GUARANTEE

Serie	K	Finish	Driver	W	V	Hz	o	
L00122	<input type="checkbox"/>	-	<input type="checkbox"/>	20	220-240	50/60	120	1/9

ACCESORIES/ACCESSOIRES PAG 93
EMERGENCY KIT

Ref. Brand Hour / Heure

KE-1H-7W-TCI	TCI	1
KE-3H-7W-TCI	TCI	3

Serie 00-20W/00-28W



MATERIAL: ZAMAK AND ACRYLIC.

MATIÈRE: ZAMAK ET ACRYLIQUE

Finishes Couleur

- 06** White
Blanc
- 08** Gold
Doré
- 19** Antic Brass
Cuir
- 22** Chrome
Chrome
- 42** Satin nickel
Nickel satiné
- 68** Matt gold
Doré mat
- 72** Matt chrome
Chrome mat



K	TC (K)	Chip lm L00122	Chip lm L00128
621	3000	2840 (142 lm/W)	3830 (137 lm/W)
620	4000	2980 (149 lm/W)	4010 (143 lm/W)
625	5000	3060 (153 lm/W)	4130 (147 lm/W)

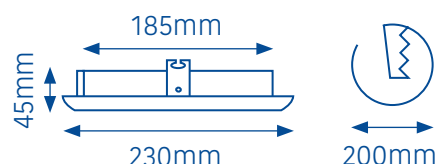

Driver	Driver Brand	Dimm	Guarantee	PF
TCI-HP	TCI	NO	10	>0,95
TCI-HPD	TCI	1-10V/PUSH	10	>0,95
HP-DALI	TCI	DALI	10	>0,92



LED CHIP: SAMSUNG SMD 5630 CRI > 80 - L80/B20 / 80,000 hours ; 3SDCM; 10 YEARS GUARANTEE

Serie	K	Finish	Driver	W	V	Hz	o	
L00122	<input type="checkbox"/>	-	<input type="checkbox"/>	20	220-240	50/60	120	1/9
L00128	<input type="checkbox"/>	-	<input type="checkbox"/>	28	220-240	50/60	120	1/9

ACCESORIES/ACCESSOIRES PAG 93
EMERGENCY KIT

Ref.	Brand	Hour / Heure
KE-1H-7W-TCI	TCI	1
KE-3H-7W-TCI	TCI	3

Serie 51-20W



MATERIAL: ZAMAK AND ACRYLIC.

MATIÈRE: ZAMAK ET ACRYLIQUE

Finishes Couleur

- White Blanc **06**
- Satin nickel Nickel satiné **42**
- Matt chrome Chrome mat **72**

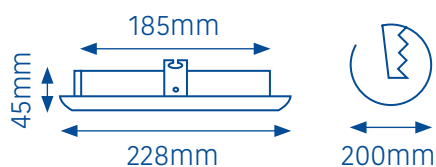

K	TC (K)	Chip lm
621	3000	2100 (105 lm/W)
620	4000	2200 (110 lm/W)
626	6000	2300 (115 lm/W)

Driver	Driver Brand	Dimm	Guarantee	PF
-	A.A. SPAIN	NO	5	>0,9
TCI	TCI	NO	7	>0,95
DIMM	TCI	1-10V/PUSH	7	>0,95
DALI	TCI	DALI	7	>0,92



LED CHIP: EPISTAR SMD 5630 ; CRI > 80 / 36,000 hours ; 3 YEARS GUARANTEE

Serie	K	Finish	Driver	W	V	Hz	o	
L51122	<input type="checkbox"/>	-	<input type="checkbox"/>	20	220-240	50/60	120	1/9

ACCESORIES/ACCESSOIRES PAG 93
EMERGENCY KIT

Ref. Brand Hour / Heure

KE-1H-7W-TCI	TCI	1
KE-3H-7W-TCI	TCI	3

Serie 51-20W/51-28W



MATERIAL: ZAMAK AND ACRYLIC.

MATIÈRE: ZAMAK ET ACRYLIQUE



Finishes Couleur

- 06** White
Blanc
- 42** Satin nickel
Nickel satiné
- 72** Matt chrome
Chrome mat

K	TC (K)	Chip lm L51122	Chip lm L51128
621	3000	2840 (142 lm/W)	3830 (137 lm/W)
620	4000	2980 (149 lm/W)	4010 (143 lm/W)
625	5000	3060 (153 lm/W)	4130 (147 lm/W)

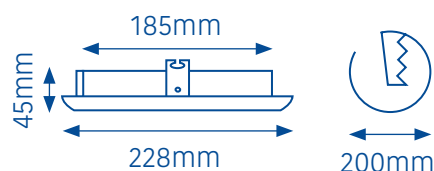

Driver	Driver Brand	Dimm	Guarantee	PF
TCI-HP	TCI	NO	10	>0,95
TCI-HPD	TCI	1-10V/PUSH	10	>0,95
HP-DALI	TCI	DALI	10	>0,92



LED CHIP: SAMSUNG SMD 5630 CRI > 80 - L80/B20 / 80,000 hours; 3SDCM; 10 YEARS GUARANTEE

Serie	K	Finish	Driver	W	V	Hz	o	
L51122	<input type="checkbox"/>	-	<input type="checkbox"/>	20	220-240	50/60	120	1/9
L51128	<input type="checkbox"/>	-	<input type="checkbox"/>	28	220-240	50/60	120	1/9

ACCESORIES/ACCESSOIRES PAG 93

EMERGENCY KIT

Ref.	Brand	Hour / Heure
KE-1H-7W-TCI	TCI	1
KE-3H-7W-TCI	TCI	3

Serie 56-20W



MATERIAL: ZAMAK AND ACRYLIC.

MATIÈRE: ZAMAK ET ACRYLIQUE

Finishes Couleur

- White Blanc **06**
- Satin nickel Nickel satiné **42**
- Matt chrome Chrome mat **72**

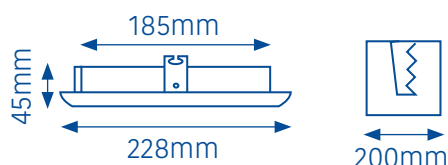

K	TC (K)	Chip lm
621	3000	2100 (105 lm/W)
620	4000	2200 (110 lm/W)
626	6000	2300 (115 lm/W)

Driver	Driver Brand	Dimm	Guarantee	PF
-	A.A. SPAIN	NO	5	>0,9
TCI	TCI	NO	7	>0,95
DIMM	TCI	1-10V / PUSH	7	>0,95
DALI	TCI	DALI	7	>0,92



LED CHIP: EPISTAR SMD 5630 ; CRI > 80 / 36,000 hours ; 3 YEARS GUARANTEE

Serie	K	Finish	Driver	W	V	Hz	o	
L56122	<input type="checkbox"/>	-	<input type="checkbox"/>	20	220-240	50/60	120	1/5

ACCESORIES/ACCESSOIRES PAG 93
EMERGENCY KIT

Ref. Brand Hour / Heure

KE-1H-7W-TCI TCI 1

KE-3H-7W-TCI TCI 3

Soner

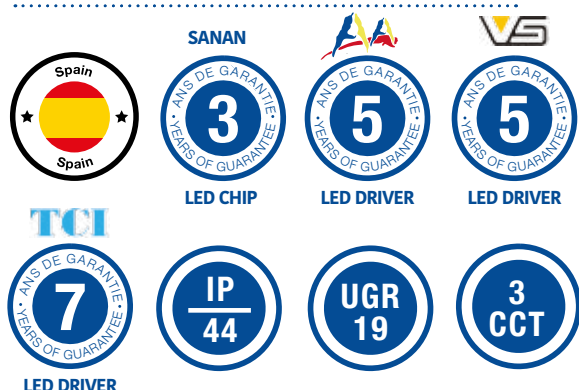

MATERIAL: LUMINIUM AND PMMA.

MATIÈRE: ALUMINIUM ET PMMA

Finishes
Couleur

How it works
Comment ça marche



400 White
Blanc

Driver	Driver Brand	Dimm	Guarantee	PF
-	AA SPAIN	NO	5	>0,9
TCI	TCI	NO	7	>0,95
VS	VOSSLOH SCHWABE (Made in P.R.C.)	NO	5	>0,97
DIMM	TCI	1-10V / PUSH	7	>0,95
DALI	TCI	DALI	7	>0,92
VS-DALI	VOSSLOH SCHWABE (Made in Italy)	DALI	5	>0,95

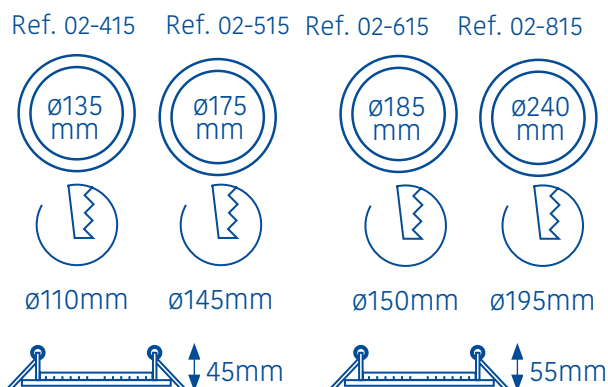

ACCESORIES/ACCESSOIRES PAG 93
EMERGENCY KIT

Ref.	Brand	Hour / Heure
KE-1H-7W-TCI	TCI	1
KE-3H-7W-TCI	TCI	3



LED CHIP: SANAN SMD 5630 ; CRI > 80 / 36,000 hours ; 15,000 ON/OFF; 3 YEARS GUARANTEE

Serie	W	Finish	DRIVER	K	lm	V	Hz	o	
02-415	- 15	- 400	- <input type="checkbox"/>	3000/4000/5500	1730	220-240	50/60	120	1/20
02-515	- 15	- 400	- <input type="checkbox"/>	3000/4000/5500	1730	220-240	50/60	120	1/20
02-615	- 20	- 400	- <input type="checkbox"/>	3000/4000/5500	2260	220-240	50/60	120	1/20
02-815	- 20	- 400	- <input type="checkbox"/>	3000/4000/5500	2260	220-240	50/60	120	1/20
02-815	- 30	- 400	- <input type="checkbox"/>	3000/4000/5500	3370	220-240	50/60	120	1/20

** Available with only 1 CCT, MOQ, 500 pcs

** Disponible avec seulement 1 CCT, MOQ, 500 pcs.

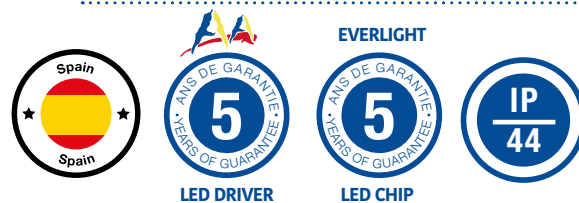
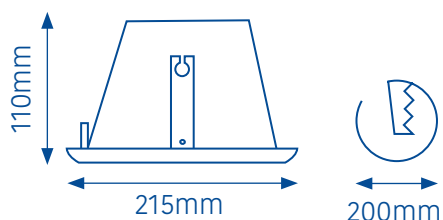

MATERIAL: ALUMINIUM AND POLYCARBONATE
MATIÈRE: ALUMINIUM ET POLYCARBONATE

Finish	Finish/Couleur	TC (K)	Chip lm	UGR
300	White	3000	2700 (90 lm/W)	<22
301	White-Inox	3000	2700 (90 lm/W)	<19
000	White	4000	2850 (95 lm/W)	<22
001	White-Inox	4000	2850 (95 lm/W)	<19
570	White	6500	3000 (100 lm/W)	<22
571	White-Inox	6500	3000 (100 lm/W)	<19

Driver	Driver Brand	Dimm	Guarantee	PF
-	A.A. SPAIN	NO	5	>0,9
DIMM	A.A. SPAIN	1-10V	5	>0,9
PUSH	A.A. SPAIN	PUSH	5	>0,9
DALI	A.A. SPAIN	DALI	5	>0,9



LED CHIP: EVERLIGHT SMD 2835 ; CRI > 80 / 50,000 hours ; 15,000 ON/OFF; 5 YEARS GUARANTEE

Serie	W	Finish	Bult inDriver	V	Hz	o	Icon
02-771	-	30	-	220-240	50/60	90	1/12

** 1-10V, PUSH & DALI version, MOQ: 500 pcs.



Sirion



MATERIAL: ALUMINIUM

MATIÈRE: ALUMINIUM

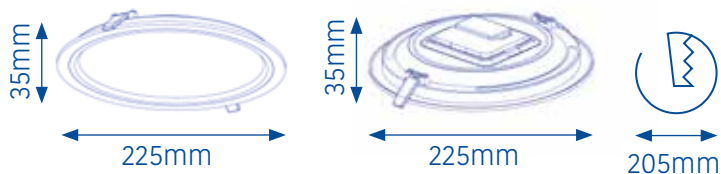

Reference	W	Led	K	Lm	Chip
02-633-25-300	25	SMD2835	3000	1875	EPISTAR
02-633-25-400	25	SMD2835	4000	1875	EPISTAR
02-633-25-600	25	SMD2835	6000	1875	EPISTAR

Tekia



MATERIAL: ALUMINIUM AND POLYCARBONATE
PIR SENSOR: INFRARED INDUCTION
ALUMINIUM FRAMES IN OTHER FINISHES AVAILABLE

MATIÈRE: ALUMINIUM ET POLYCARBONATE
CAPTEUR PIR: INDUCTION INFRAROUGE
CADRES EN ALUMINIUM DDANS D'AUTRES FINITIONS DISPONIBLES

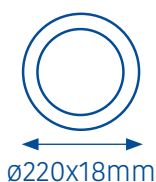

Cut-Off

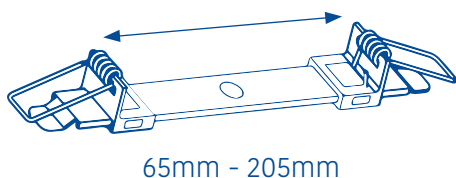

LED CHIP: EPISTAR SMD 2835 ; 120 LED chips; CRI > 80 / 30,000 hours; 15,000 ON/OFF; 2 YEARS GUARANTEE

SERIE	W	lm	V	Hz	P.F.	o	Sensing Distance	Sensing Angle	Sensing Duration (selectable)	
02-943-18-333	18	1620 (90 lm/W)	220-240	50/60	>0.5	110	3,5 - 4 m.	110°	30/180 s.	1/20

ACCESORIES/ACCESSOIRES

Ref.	Finish
02-943-18-Aro-Negro	Black/Noir
02-943-18-Aro-Plata	Silver/Argenté

Know



Ref. 02-100-12-400



Spain

SANAN



LED CHIP



LED DRIVER



LED DRIVER

MATERIAL: ALUMINIUM AND ACRYLIC

MATIÈRE: ALUMINIUM ET ACRYLIQUE

Finishes Couleur

- White Blanc **400**
- Grey Gris **181**

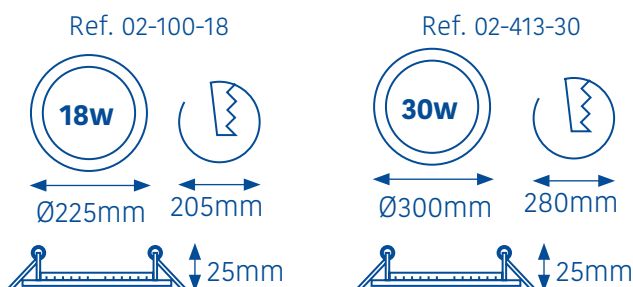
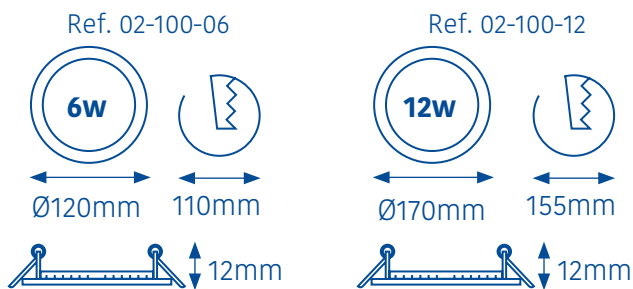

Driver	Driver Brand	Dimm	Guarantee	PF
-	AA. SPAIN	NO	2	> 0,50
TCI	TCI	NO	7	> 0,95

IP	IP Rating
-	20
IP44	44



LED CHIP: SANAN SMD 5630 ; CRI > 80 / 30,000 hours ; 20,000 ON/OFF; 2 YEARS GUARANTEE

Serie	W	Finish	Driver	IP	K	Lm	V	Hz	o	
02-100	- 06	-	-	-	4000	480 (80lm/W)	220-240	50/60	120	1/20
02-100	- 12	-	-	-	4000	960 (80lm/W)	220-240	50/60	120	1/20
02-100	- 18	-	-	-	4000	1440 (80lm/W)	220-240	50/60	120	1/20
02-413	- 30	-	-	-	4000	2450 (80lm/W)	220-240	50/60	120	1/10

** IP44, MOQ: 500 pcs ** 3000 K and 6000K are also available upon request, MOQ: 300 pcs.

IP 44, MOQ 500pcs 3000 K et 6000K sont disponibles sur demande, MOQ: 300 pcs



Ref. 02-200-12-181

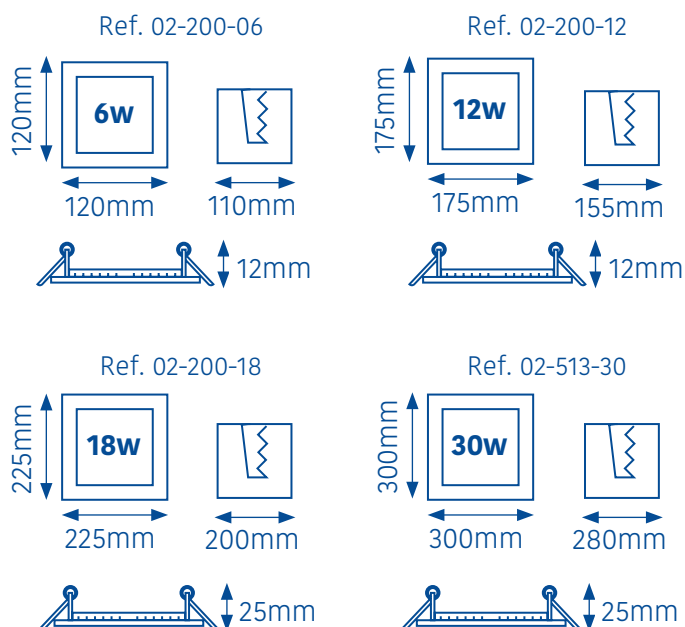

LED CHIP: SANAN SMD 5630 ; CRI > 80 / 30,000 hours ; 20,000 ON/OFF; 2 YEARS GUARANTEE

Serie	W	Finish	Driver	IP	K	Lm	V	Hz	o	
02-200	- 06	-	-	-	4000	480 (80lm/W)	220-240	50/60	120	1/20
02-200	- 12	-	-	-	4000	960 (80lm/W)	220-240	50/60	120	1/20
02-200	- 18	-	-	-	4000	1440 (80lm/W)	220-240	50/60	120	1/20
02-513	- 30	-	-	-	4000	2450 (80lm/W)	220-240	50/60	120	1/10

** IP44, MOQ: 500 pcs ** 3000 K and 6000K are also available upon request, MOQ: 300 pcs.

IP 44, MOQ 500pcs 3000 K et 6000K sont disponibles sur demande, MOQ: 300 pcs



Ángel Aparicio Spain

**LED SURFACE MOUNTED
DOWNLIGHTS**

LED PLAFONNIERS



Know



Ref. 02-300-18-400



MATERIAL: ALUMINIUM AND ACRYLIC

MATIÈRE: ALUMINIUM ET ACRYLIQUE

Finishes Couleur

- White Blanc **400**
- Grey Gris **181**

Ref. 02-300-06



Ref. 02-300-12



Ref. 02-300-18

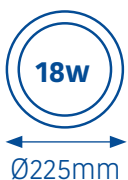

Ref. 02-433-30



Driver	Driver Brand	Dimm	Guarantee	PF
-	AA. SPAIN	NO	2	> 0,50
TCI	TCI	NO	7	> 0,95



LED CHIP: SANAN SMD 2835 ; CRI > 80 / 30,000 hours ; 20,000 ON/OFF; 2 YEARS GUARANTEE

Serie	W	Finish	Driver	K	Lm	V	Hz	o	
02-300	- 06	-		4000	480 (80lm/W)	220-240	50/60	120	1/20
02-300	- 12	-		4000	960 (80lm/W)	220-240	50/60	120	1/20
02-300	- 18	-		4000	1440 (80lm/W)	220-240	50/60	120	1/20
02-433	- 30	-		4000	2450 (80lm/W)	220-240	50/60	120	1/10

** 3000 K and 6000K are also available upon request, MOQ: 300 pcs.

** 3000 K et 6000K sont disponibles sur demande, MOQ: 300 pcs



Ref. 02-600-18-400

Ref. 02-600-06

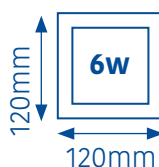

Ref. 02-600-12

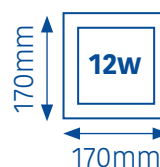

Ref. 02-600-18

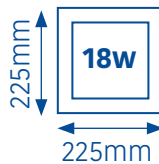

Ref. 02-533-30

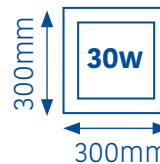

LED CHIP: SANAN SMD 2835 ; CRI > 80 / 30,000 hours ; 20,000 ON/OFF; 2 YEARS GUARANTEE

Serie	W	Finish	Driver	K	Lm	V	Hz	o	
02-600	- 06	-	-	4000	480 (80lm/W)	220-240	50/60	120	1/20
02-600	- 12	-	-	4000	960 (80lm/W)	220-240	50/60	120	1/20
02-600	- 18	-	-	4000	1440 (80lm/W)	220-240	50/60	120	1/20
02-533	- 30	-	-	4000	2450 (80lm/W)	220-240	50/60	120	1/10

** IP44, MOQ: 500 pcs ** 3000 K and 6000K are also available upon request, MOQ: 300 pcs.

IP 44, MOQ 500pcs 3000 K et 6000K sont disponibles sur demande, MOQ: 300 pcs

Know



Ref. 02-354-18-400

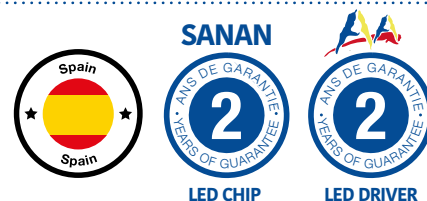

MATERIAL: ALUMINIUM AND ACRYLIC
MATIÈRE: ALUMINIUM ET ACRYLIQUE

Finishes Couleur

- Sand White / Blanc Texturé **401**
- Anthracite Grey / Gris Anthacite **182**
- White / Blanc **400**
- Grey / Gris **181**

Ref. 02-354-06



Ref. 02-354-12



Ref. 02-354-18



Ref. 02-354-30



LED CHIP: SANAN SMD 2835 ; CRI > 80 / 30,000 hours ; 20,000 ON/OFF; 2 YEARS GUARANTEE

Serie	W	Finish	K	Lm	V	Hz	o	
02-354	- 06	-	4000	480 (80lm/W)	220-240	50/60	120	1/20
02-354	- 12	-	4000	960 (80lm/W)	220-240	50/60	120	1/20
02-354	- 18	-	4000	1440 (80lm/W)	220-240	50/60	120	1/20
02-354	- 30	-	4000	2450 (80lm/W)	220-240	50/60	120	1/10

** 3000 K and 6000K are also available upon request, MOQ: 300 pcs.

** 3000 K et 6000K sont disponibles sur demande, MOQ: 300 pcs



Ref. 02-654-18-182

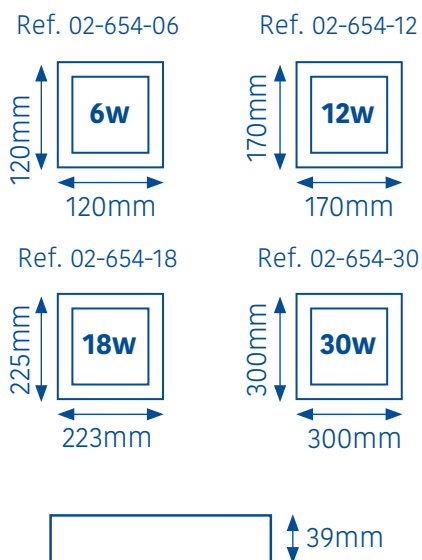

LED CHIP: SANAN SMD 2835 ; CRI > 80 / 30,000 hours ; 20,000 ON/OFF; 2 YEARS GUARANTEE

Serie	W	Finish	K	Lm	V	Hz	o	
02-654	- 06	-	4000	480 (80lm/W)	220-240	50/60	120	1/20
02-654	- 12	-	4000	960 (80lm/W)	220-240	50/60	120	1/20
02-654	- 18	-	4000	1440 (80lm/W)	220-240	50/60	120	1/20
02-654	- 30	-	4000	2450 (80lm/W)	220-240	50/60	120	1/10

** IP44, MOQ: 500 pcs ** 3000 K and 6000K are also available upon request, MOQ: 300 pcs.

IP 44, MOQ 500pcs 3000 K et 6000K sont disponibles sur demande, MOQ: 300 pcs

Ice



MATERIAL: ALUMINIUM AND ACRYLIC
MATIÈRE: ALUMINIUM ET ACRYLIQUE

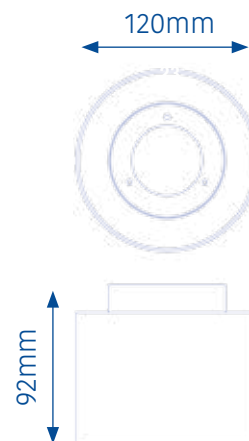

LED CHIP: EPISTAR SMD 2835 ; CRI > 80 / 30,000 hours ; 20,000 ON/OFF; 2 YEARS GUARANTEE

Serie	Finish	W main light	W side light	V	Hz	o	Pf	
43-861-01	- 	12	4	220-240	50/60	45	0,5	1/20

Finish	Finish / Couleur	Tc (K) Main Light	Tc (K) Side Light	lm main light	lm side light
000	White / Blanc	4000	3000	890	197
300	White / Blanc	3000	3000	870	197
002	Nickel/Nickel	4000	3000	890	197

Ice



MATERIAL: ALUMINIUM AND ACRYLIC

MATIÈRE: ALUMINIUM ET ACRYLIQUE

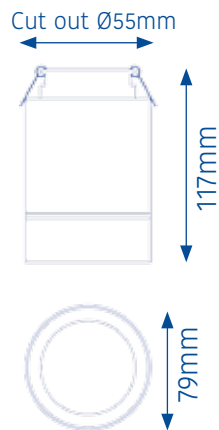

LED CHIP: EPISTAR SMD 2835 ; CRI > 80 / 30,000 hours ; 20,000 ON/OFF; 2 YEARS GUARANTEE

Serie	Finish	W	lm	V	Hz	o	Pf	
43-055-01	-	9	412	220-240	50/60	45	0,5	1/20

Finish	Finish / Couleu	Tc (K) Light
000	White / Blanc	4000
300	White / Blanc	3000
002	Nickel/Nickel	4000

Dalia



MATERIAL: POLYCARBONATE

MATIÈRE: POLYCARBONATE

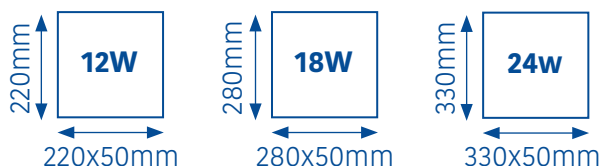

ED CHIP: EPISTAR SMD 2835 ; CRI > 80 / 25,000 hours ; 15,000 ON/OFF; 2 YEARS GUARANTEE

Serie	W	Model + K	V	Hz	o	Pf	
23-845	- 12	-	220-240	50/60	120	>0,5	1/10
24-845	- 18	-	220-240	50/60	120	>0,5	1/10
25-845	- 24	-	220-240	50/60	120	>0,5	1/10

Model	Model	K	Tc (K)	W	lm
10	BASIC	3	3000	12-18 24	1235-1700-2200
20	PIR SENSOR	4	4000	12-18-24	1300-1860-2500
30	1 HOUR EMERGENCY KIT	6	6400	12-18-24	1188-1822-2440
31	1,5 HOUR EMERGENCY KIT				

Dalia







MATERIAL: POLYCARBONATE

MATIÈRE: POLYCARBONATE



LED CHIP: EPISTAR SMD 2835 ; CRI > 80 / 30,000 hours ; 20,000 ON/OFF; 2 YEARS GUARANTEE

Serie	W	Model + K	V	Hz	o	Pf	
23-545	- 12	- 	220-240	50/60	120	>0,5	1/10
24-545	- 18	- 	220-240	50/60	120	>0,5	1/10
25-545	- 24	- 	220-240	50/60	120	>0,5	1/10

Model	Model	K	Tc (K)	W	lm
10	BASIC	3	3000	12-18-24	1235-1700-2200
20	PIR SENSOR	4	4000	12-18-24	1300-1860-2500
30	1 HOUR EMERGENCY KIT	6	6400	12-18-24	1188-1822-2440
31	1,5 HOUR EMERGENCY KIT				



Ángel Aparicio Spain

LED MIRROR LIGHTS
APPLIQUE MIROIR LED





Málaga



MATERIAL: ALUMINIUM, ABS AND EBIREX
LIGHT BEAM.

APPLIQUE MIROIR LED
MATIÈRE: ALUMINIUM, ABS ET EBIREX.

Light beam
Faisceau lumineux

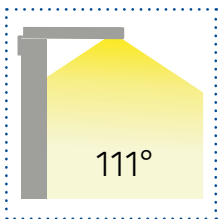

Photometric curves
Courbes photométriques

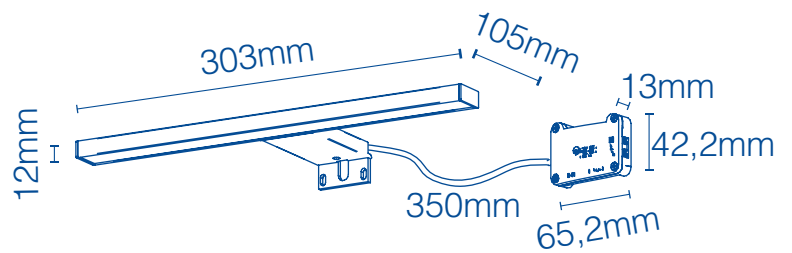
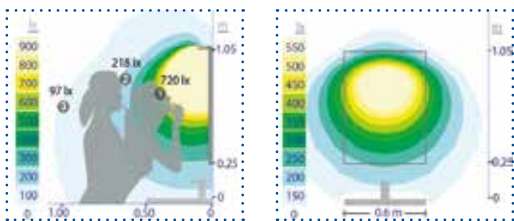

Reference W Led K Lm Class

43-286-06-001 7 AC 5700 417 II

Álava



MATERIAL: ALUMINIUM, ABS AND EBIREX LIGHT BEAM.

APPLIQUE MIROIR LED
MATIÈRE: ALUMINIUM, ABS ET EBIREX.

Light beam
Faisceau lumineux

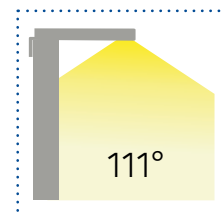

Photometric curves
Courbes photométriques

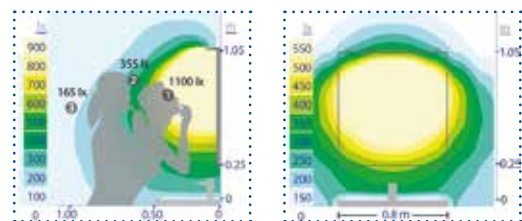
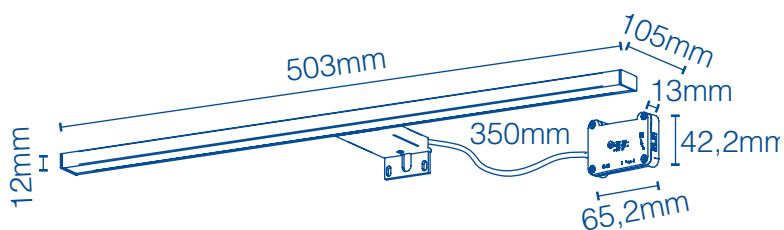

36.000H

Reference W Led K Lm Class

43-866-10-001 11 AC 5700 710 II

Zaragoza



MATERIAL: ALUMINIUM, ABS AND EBIREX
LIGHT BEAM.

APPLIQUE MIROIR LED
MATIÈRE: ALUMINIUM, ABS ET EBIREX.

Light beam
Faisceau lumineux

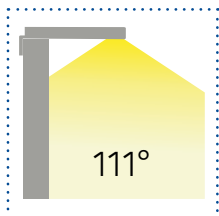

Photometric curves
Courbes photométriques

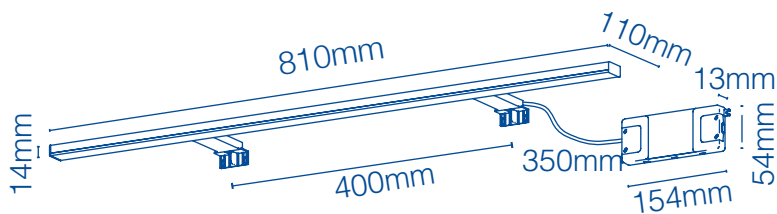
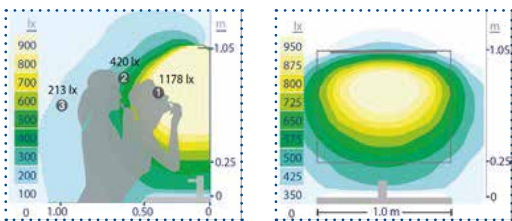

Reference W Led K Lm Class

43-567-15-001 15 AC 5700 968 II

Sevilla



LED MIRROR LIGHT
MATERIAL: EBIREX.

APPLIQUE MIROIR LED
MATIÈRE: EBIREX.

Light beam
Faisceau lumineux

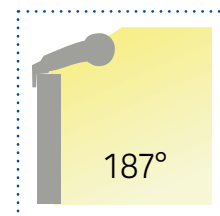

Photometric curves
Courbes photométriques

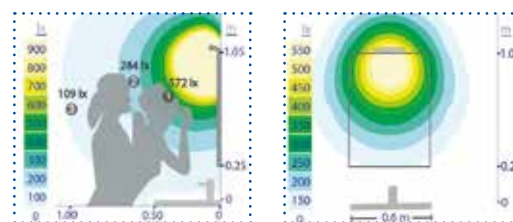
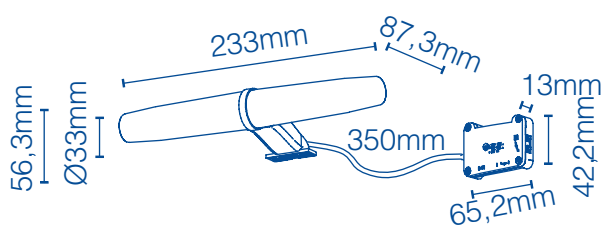

36.000H

Reference	W	Led	K	Lm	Class
43-690-06-001	6	AC	4000	392	II

Mallorca



LED MIRROR LIGHT
MATERIAL: EBIREX.

APPLIQUE MIROIR LED
MATIÈRE: EBIREX

Light beam
Faisceau lumineux

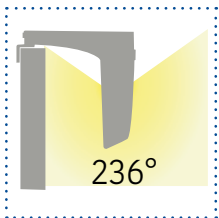

Photometric curves
Courbes photométriques

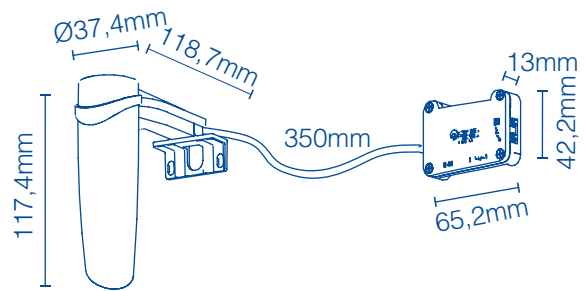
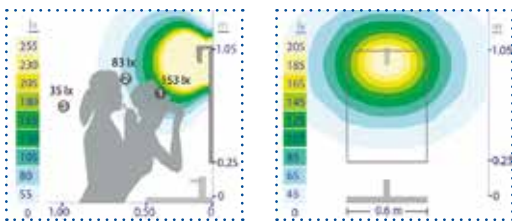

36.000H

Reference W Led K Lm Class

43-898-03-001 2 AC 4000 140 II





Ángel Aparicio Spain

**LED FLOODLIGHT
PROJECTEUR LED**





MATERIAL: DIE CAST ALUMINIUM AND TEMPERED GLASS
INTEGRATED JUNCTION BOX
EASY TO INSTALL

MATIÈRE : ALUMINIUM MOULÉ SOUS
PRESSION ET VERRE TREMPÉ
BOÎTE DE JONCTION INTÉGRÉE
FACILE À INSTALLER

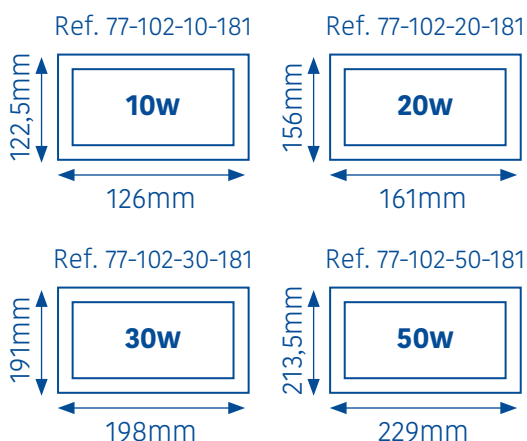

W	Chip lm	K	Tc (K)
10	800 (80 lm/W)	381	3000
20	1600 (80 lm/W)	481	4000
30	2400 (80 lm/W)	181	6400
50	4000 (80 lm/W)		



LED CHIP: EPISTAR SMD 2835 ; CRI > 80 / 25,000 hours ; 15,000 ON/OFF; 2 YEARS GUARANTEE

Serie	W	K	V	Hz	o	Pf	TA	Icon		
77-102	-	□□	-	□□□□	180-260	50/60	120	>0,9	-20,+55°C	1/20

** K, 381 & 481, MOQ: 300 pcs

Baco



MATERIAL: DIE CAST ALUMINIUM AND TEMPERED GLASS INTEGRATED JUNCTION BOX
EASY TO INSTALL

MATIÈRE : ALUMINIUM MOULÉ SOUS PRESSION ET VERRE TREMPÉ BOÎTE DE JONCTION INTÉGRÉE
FACILE À INSTALLER

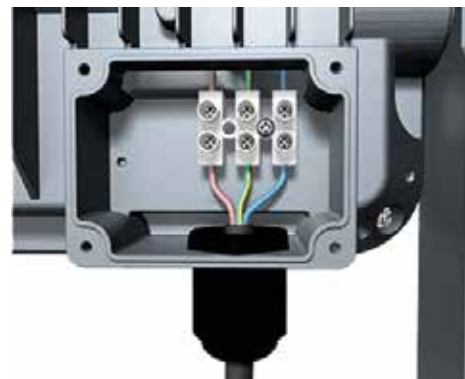
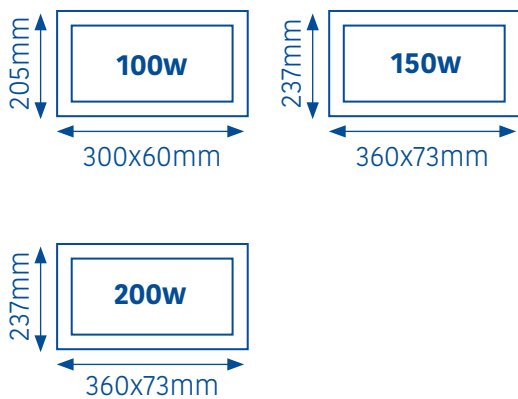

W	Watt	Chip lm	K	Tc (K)
10	100	10,000 (100 lm/W)	381	3000
15	150	15,000 (100 lm/W)	481	4000
20	200	20,000 (100 lm/W)	681	6400



LED CHIP: EPISTAR SMD 2835 ; CRI > 80 / 25,000 hours ; 15,000 ON/OFF; 2 YEARS GUARANTEE

Serie	W	K	V	Hz	o	Pf	TA		
77-103	-			180-260	50/60	120	>0,9	-20,+55°C	1/6



A photograph of a retail store interior. On the left, a wooden shelving unit displays various handbags and shoes. On the right, a glass shelving unit displays more shoes and handbags. The background wall is dark with a grid of small, glowing white dots. The ceiling is a white grid with recessed lighting. A blue banner is overlaid at the bottom of the image.

Ángel Aparicio Spain

LED PANELS
PANNEAUX LED



60x60 Led Panel 1CCT

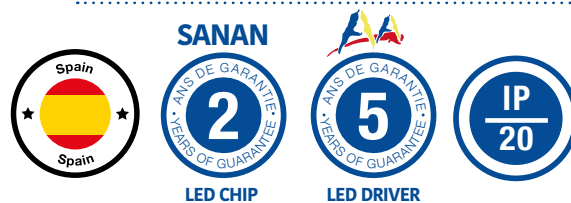
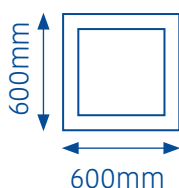

MATERIAL: LGP, 3.00 MM PS

MATIÈRE: LGP, 3.00 MM PS

K	Tc(K)	IP	IP
270	2700	-	20
400	4000	IP44	44
600	6000	IP65	65



** Other K available, upon minimum request, MOQ: 500 pcs.

** Autres K disponible pour commande minimum MOQ 500 pcs**

Driver	Driver Brand	Dimm	Guarantee	PF
-	AA. SPAIN	NO	5	> 0,9
TCI	TCI	NO	7	> 0,95
DIMM	TCI	1-10 / PUSH	7	> 0,95
DALI	TCI	DALI	7	> 0,95

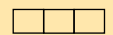

LED CHIP: SANAN SMD 4014 ; CRI > 80 / 50,000 hours ; 15,000 ON/OFF; 2 YEARS GUARANTEE

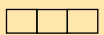
Serie	W	K	IP	Driver	Lm	V	Hz	o	
30-125	- 40				3600	220-240	50/60	120	1/5

AVAILABLE SURFACE FRAME



Ref. 30-550-40-PER

ACCESORIES/ACCESSOIRES PAG 93
EMERGENCY KIT

Ref.	Brand	Hour / Heure
KE-1H-7W-TCI	TCI	1
KE-3H-7W-TCI	TCI	3

60x60 Led Panel 3CCT



MATERIAL: ALUMINIUM & ACRYLIC

MATIÈRE: ALUMINIUM ET ACRYLIQUE



IP	IP
-	20
IP44	44
IP65	65

** IP44 and IP65, upon minimum request, MOQ: 500 pcs.

** P44 and IP65 disponible pour commande minimum MOQ 500 pcs**

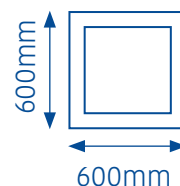

Driver	Driver Brand	Dimm	Guarantee	PF
-	AA. SPAIN	NO	5	> 0,9
TCI	TCI	NO	7	> 0,95
DIMM	TCI	1-10 / PUSH	7	> 0,95
DALI	TCI	DALI	7	> 0,95



LED CHIP: SANAN SMD ; CRI > 85 / 50,000 hours ; 15,000 ON/OFF; 2 YEARS GUARANTEE

Serie	IP	Driver	K	Lm	V	Hz	PF	o	
30-125-40-333	-		3000/4000/6500	3700	85-265	50/60	>0,9	120	1/5

ACCESORIES/ACCESSOIRES PAG 93
EMERGENCY KIT

Ref.	Brand	Hour / Heure
KE-1H-7W-TCI	TCI	1
KE-3H-7W-TCI	TCI	3

AVAILABLE SURFACE FRAME



Ref. 30-550-40-PER

Frame Led

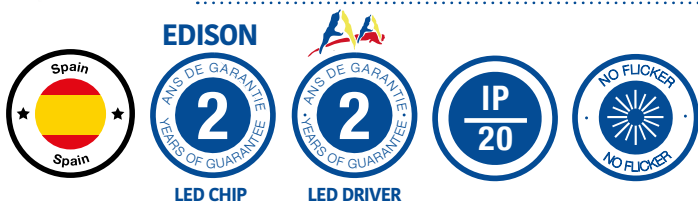
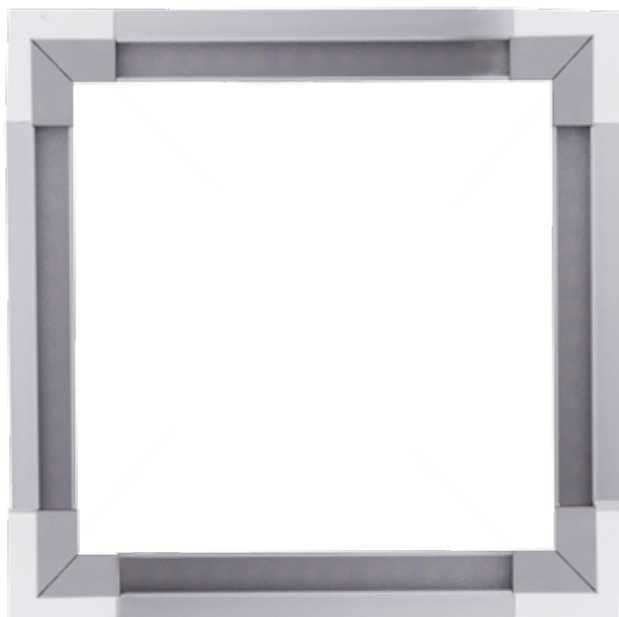

MATERIAL: ALUMINIUM & POLYCARBONATE

MATIÈRE: ALUMINIUM ET POLYCARBONATE

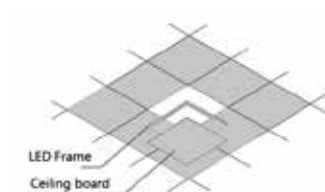
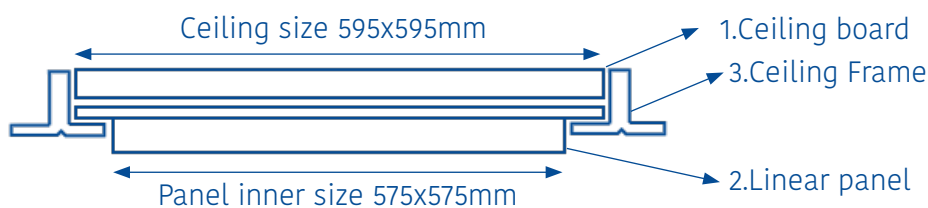

LED CHIP: EDISON SMD 4014 ; CRI > 80 / 25,000 hours ; 13,000 ON/OFF ; 2 YEARS GUARANTEE

Serie	W	K	Lm	V	Hz	PF	o	
30-440-40-400	40	4000	3200	175-250	50/60	>0,9	110	1/5

Eduba

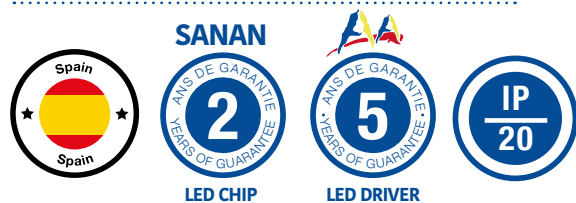

SURFACE MOUNTED LED PANEL.
MATERIAL: ALUMINIUM & ACRYLIQUE

PANNEAU LED DE SOURFACE.
MATIÈRE: ALUMINIUM ET ACRYLIQUE

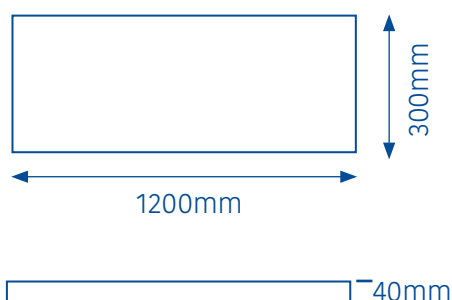

LED CHIP: SANAN SMD 4014 ; CRI > 80 / 30,000 hours ; 15,000 ON/OFF; 2 YEARS GUARANTEE

Serie	W	K	Lm	V	Hz	PF	o	
43-519-48-333	40	3000/ 4000/6000	4080	85-265	50/60	>0,5	120	1/4

ACCESSORIES/ACCESSOIRES PAG 93
EMERGENCY KIT

Ref.	Brand	Hour / Heure
KE-1H-7W-TCI	TCI	1
KE-3H-7W-TCI	TCI	3





Ángel Aparicio Spain

LED STRIPS
BANDES LED



Led Strips



MATERIAL: FPC (FLEXIBLE CIRCUIT BOARD),
HIGHLY RELIABLE. CAN BE CUT BY 6 LEDS (24 V)
10 METERS IN SERIAL CONNECTION IS THE
MAXIMUM RECOMMENDED

MATIÈRE : MATÉRIAU : FPC (FLEXIBLE CIRCUIT BOARD),
TRÈS FIABLE. PEUT ÊTRE COUPÉ PAR 6 LEDS (24 V)
10 MÈTRES DE CONNEXION EN SÉRIE
EST LE MAXIMUM RECOMMANDÉ



LED CHIP: EPISTAR SMD 5050 ; CRI > 80 / 50,000 hours ; P.F. > 0,9, 5 YEARS GUARANTEE

Serie	IP	K	W	m.	No. Leds/m.	V	Hz	o	Storage Temperature	Operating temperature		
18-006	-			14,4 W/m.	5 per reel	60	24	50/60	120	-40 .. +80 °C	-20 .. +60°C	1/25

** Other K and W are available upon request, MOQ: 200 rolls

** Autres K et W disponibles sur demande, MOQ : 200 rouleaux







IP	Drawing	Specification
20		With 3M adhesive tape back, easy for installation. Avec adhésif 3M au verso, facile à poser
67		Square silicon tube Tube carré en silicone
68		Silicon tube + silicon glue inside Tube de silicone + colle de silicone à l'intérieur

K	Tc (K)	lm/m. IP20	lm/m. IP67	lm/m. IP68
270	2700	960	980	980
400	4000	960	980	980
600	6000	960	980	980

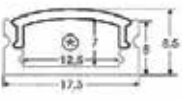

ACCESORIES/ACCESSOIRES

ALUMINUM PROFILES

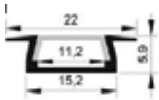
Ref.	Pc Cover Finish	Picture	Drawing	Specification
18-006-CORNER	- TR (Transparent) MK (Milky)			Profile for corners SIZE: 16*16*1000mm 1set = 1m Al. Profile + 1m PC + 2 pcs end caps + 2 pcs clips
18-006-SPF	- TR (Transparent) MK (Milky)			Profile to be surface mounted SIZE: 15,9*16*1000mm 1set = 1m Al. Profile + 1m PC + 2 pcs end caps
18-006-SPF2	- TR (Transparent) MK (Milky)			Profile to be surface mounted SIZE: 17,3*8,5*2000mm 1set = 2m Al. Profile + 2m PC + 2 pcs end caps
18-006-REC	- TR (Transparent) MK (Milky)			Profile to be recessed SIZE: 16*16*1000mm 1set = 1m Al. Profile + 1m PC + 2 pcs end caps

POWER SUPPLIES DC 24V



A.A. SPAIN

IP20

VOSSLOH - SCHWABE
(Made in P.R.C.)*

A.A. SPAIN

IP67

VOSSLOH - SCHWABE
(Made in P.R.C.)*



75W	Ref. Size	FUS24-75W-IP20-VS 180 x 52 x 30 mm.	FUS24-75W-IP67-VS 155 x 49 x 32 mm.
100W	Ref. Size		FUS-24-100-67-18-006 180 x 60 x 39 mm.
120W	Ref. Size	FUS24-120W-IP20-VS 300 x 40 x 30 mm.	
150W	Ref. Size	FUS24-150W-IP20 191 x 63 x 37,5 mm.	FUS24-150W-IP67-VS 206 x 68,6 x 37 mm.
180W	Ref. Size	FUS24-180W-IP20-VS 345 x 50 35 mm.	
200W	Ref. Size		FUS24-200W-IP67-VS 206 x 68,6 x 37 mm.
400W	Ref. Size		FUS-24-400-67-18-006 203 x 129 x 59 mm.
500W	Ref. Size	FUS-24-500-20-18-006 215 x 50 x 115 mm.	

* Suitable for built-in into furniture.
* Convient pour les meubles intégrés.



Ángel Aparicio Spain

**BULBS & REPLACEABLE LED
SPOT MODULES**
**AMPOULES & REMPLACEMENT
DES MODULES LED**



GU10 6W



MATERIAL: PVC

MATIÈRE: PVC

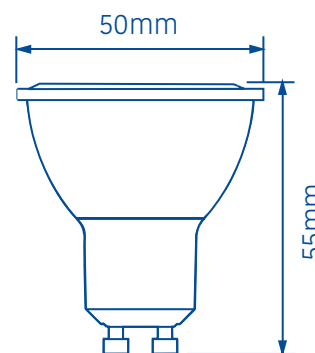

K	TC(K)
300	3000
400	4000
600	6000



0,5s-100%

LED CHIP: EPISTAR SMD 2835 ; CRI > 80 / 25,000 hours ; 15,000 ON/OFF; 3 YEARS GUARANTEE

Serie	W	K	Cap	Lm	V	Hz	o	Pf	Ma			
50-145	-	06	-		GU10	410	220-240	50/60	100	>0,5	52	1/200

ACCESORIES/ACCESSOIRES

Ref.	Holder	Material	V	Class	Cm
Plampgu1018-H	Gu10	Ceramic	100-250	II	18

GU10 8W



MATERIAL: PVC

MATIÈRE: PVC

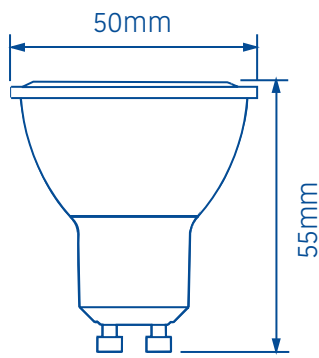

K	TC(K)
300	3000
400	4000
600	6000



0,5s-100%

LED CHIP: EPISTAR SMD 2835 ; CRI > 80 / 25,000 hours ; 15,000 ON/OFF; 3 YEARS GUARANTEE

Serie	W	K	Cap	Lm	V	Hz	o	Pf	Ma		
50-185	-	08		GU10	700	220-240	50/60	100	>0,5	69	1/200

ACCESORIES/ACCESSOIRES

Ref.	Holder	Material	V	Class	Cm
Plampgu1018-H	Gu10	Ceramic	100-250	II	18

GU10 9W



MATERIAL: POLYCARBONATE

MATIÈRE: POLYCARBONATE

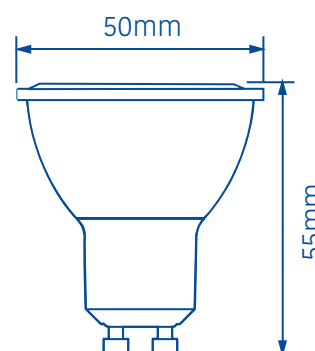

K	TC(K)
300	3000
400	4000
600	6000



0,5s-100%

LED CHIP: EPISTAR SMD 2835 ; CRI > 80 / 20,000 hours ; 15,000 ON/OFF; 2 YEARS GUARANTEE

Serie	W	K	Cap	Lm	V	Hz	o	Pf	Ma	
51-619	- 09	- <input type="checkbox"/> <input type="checkbox"/> <input type="checkbox"/>	GU10	850	175-265	50/60	70	>0,5	78	1/200

ACCESORIES/ACCESSOIRES

Ref.	Holder	Material	V	Class	Cm
Plampgu1018-H	Gu10	Ceramic	100-250	II	18

GU10 6,5W DIMM



MATERIAL: PVC

MATIÈRE: PVC

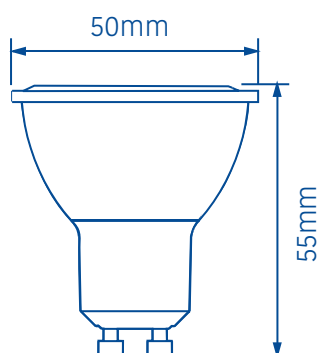

K	TC(K)
300	3000
400	4000
600	6000



LED CHIP: EPISTAR SMD 2835 ; CRI > 80 / 25,000 hours ; 15,000 ON/OFF; 3 YEARS GUARANTEE

Serie	W	K	Cap	Lm	V	Hz	o	Pf	Ma			
50-896	-	6,5	-		GU10	530	220-240	50/60	100	>0,5	56	1/200

ACCESORIES/ACCESSOIRES

Ref.	Holder	Material	V	Class	Cm
Plampgu1018-H	Gu10	Ceramic	100-250	II	18

Pack x2 MR16 5W



MATERIAL: PVC

MATIÈRE: PVC

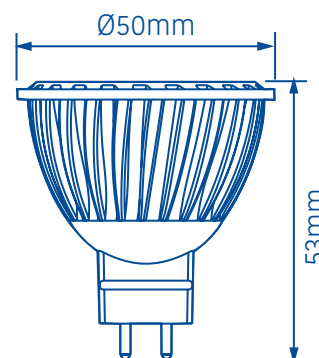

K	TC(K)
300	3000
420	4000



0,5s-100%

LED CHIP: EPISTAR SMD 2835 ; CRI > 80 / 25,000 hours ; 15,000 ON/OFF; 2YEARS GUARANTEE

Serie	W	K	Cap	Lm	V	Hz	o	Pf	Ma			
52-437	-	05	-		G 5,3	410	12	50/60	100	>0,5	30	1/200

ACCESORIES/ACCESSOIRES

Ref.	Holder	Material	V	Class	Cm
Plamp Hal 12V	MR16	Silicone	12	III	15

MR16 7W



MATERIAL: PVC

MATIÈRE: PVC

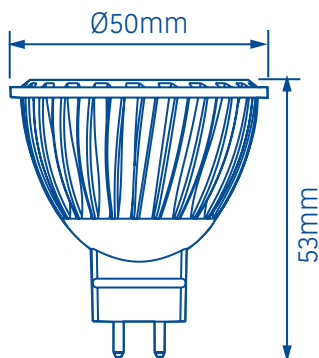

K	TC(K)
300	3000
420	4000



0,5s-100%

LED CHIP: EPISTAR SMD 2835 ; CRI > 80 / 25,000 hours ; 15,000 ON/OFF; 2 YEARS GUARANTEE

Serie	W	K	Cap	Lm	V	Hz	o	Pf	Ma		
50-437	-	07	-	G 5,3	520	12	50/60	100	>0,9	30	1/200
PACKX2 52-437	-	07	-	G 5,3	520	12	50/60	100	>0,9	30	1/200

ACCESORIES/ACCESSOIRES

Ref.	Holder	Material	V	Class	Cm
Plamp Hal 12V	MR16	Silicone	12	III	15

E14 6W



MATERIAL: PVC

MATIÈRE: PVC

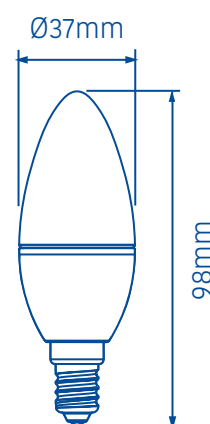

K	TC(K)
300	3000
400	4000



LED CHIP: EPISTAR SMD 2835 ; CRI > 80 / 25,000 hours ; 15,000 ON/OFF; 2 YEARS GUARANTEE

Serie	W	K	Cap	Lm	V	Hz	o	Pf	Ma	
50-797	- 06	- <input type="checkbox"/> <input type="checkbox"/> <input type="checkbox"/>	E14	470	175-250	50/60	160	>0,5	45	1/100

E27 15W



MATERIAL: PVC

MATIÈRE: PVC

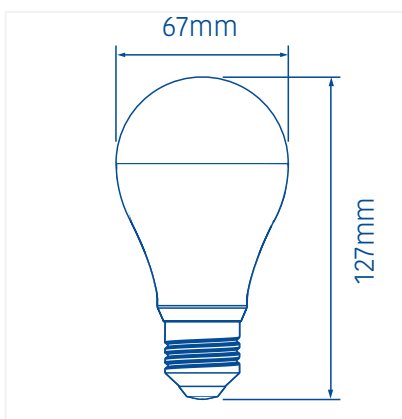

K	TC(K)
270	3000
420	4000
600	6000



0,5s-100%

LED CHIP: EPISTAR SMD 2835 ; CRI > 80 / 25,000 hours ; 15,000 ON/OFF; 2 YEARS GUARANTEE

Serie	W	K	Cap	Lm	V	Hz	o	Pf	Ma	
56-215-27	- 15	- <input type="checkbox"/>	E27	1500	220-240	50/60	220	>0,9	72	1/100

Replaceable Led Spot Module



MATERIAL: DIE CASTING+ALUMINIUM

MATIÈRE: COULÉE SOUS PRESSION + ALUMINIUM

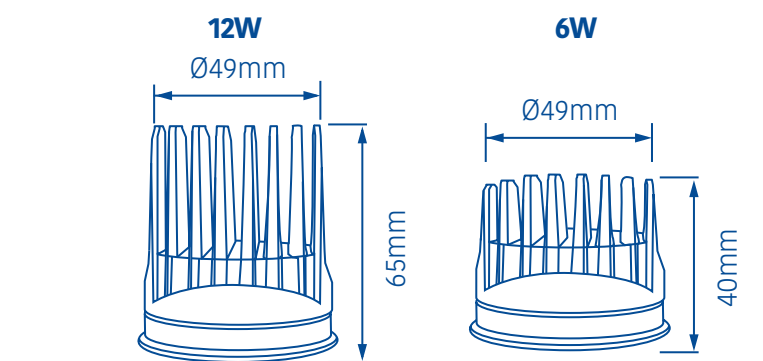

Beam Angle	TC(K)
15°	
24°	
36°	
45°	
60°	

K	TC(K)
270	2700
300	3000
400	4000



LED CHIP: EPISTAR COB; CRI > 80 /30,000 hours ; 15,000 ON/OFF; 3 YEARS GUARANTEE

Serie	W	Beam Angle	K	Driver	Lm	V	Hz	
ML3	- 06	-	-	-	480	85-265	50/60	1/180
ML3	- 12	-	-	-	960	85-265	50/60	1/120

** MOQ: 120 pcs.

Driver	Driver Brand	Dimm	Guarantee (years)	PF	Class	Ta	Tc
-	A.A. SPAIN	NO	3	0,5	II	75°C	50°C
DIMM	A.A. SPAIN	YES	3	0,5	II	75°C	50°C

Replaceable Led Spot Module



MATERIAL: DIE CASTING+ALUMINIUM

MATIÈRE: COULÉE SOUS PRESSION + ALUMINIUM



Beam Angle	TC(K)
15°	
24°	
36°	
45°	
60°	

K	TC(K)
270	2700
300	3000
400	4000

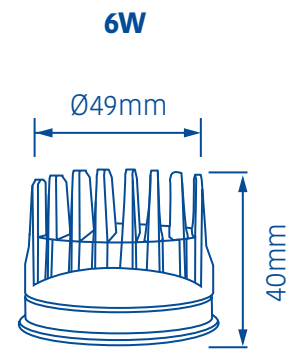
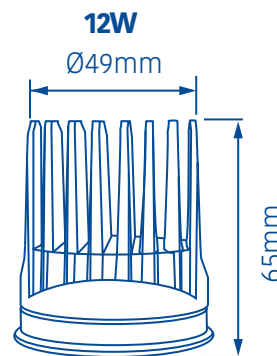

0,5s-100%

LED CHIP: EPISTAR COB; CRI > 80 /50,000 hours ; 20,000 ON/OFF; 5 YEARS GUARANTEE

Serie	W	Beam Angle	K	Driver	Lm	V	Hz	
ML5	06				480	85-265	50/60	1/180
ML5	12				960	85-265	50/60	1/120

** MOQ: 120 pcs.

Driver	Driver Brand	Dimm	Guarantee (years)	PF	Class	Ta	Tc
-	AA. SPAIN / LIFUD	NO	5	0,5	II	75°C	50°C
DIMM	OSRAM	YES	5	0,5	II	75°C	50°C



A modern interior space featuring a kitchen with wooden cabinets and glassware, a dining table with white chairs, and a living area with a grey sofa and a coffee table. A large window on the right side offers a view of a garden. The image is overlaid with a semi-transparent pattern of small white dots.

Ángel Aparicio Spain

ACCESORIES
ACCESSOIRE



Electronic Driver

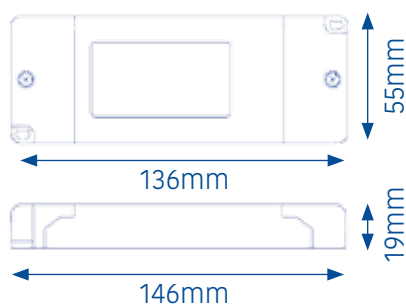
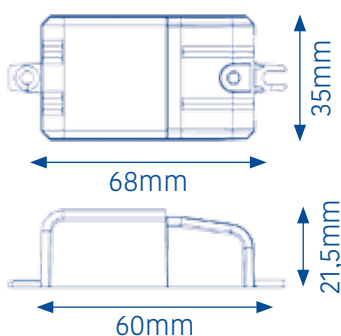

Reference	FUSDC-4-12T-TCI
Power	4W
Output current	13V DC 350mA
Input voltage	100 - 240V
Frequency	50/60Hz
ta °C	-25 + 60
tc °C	75
IP	20
Class	II
Norms	EN 50172 EN 55015 EN 61000-3-2 EN 61000-3-3 EN 61347-1 EN 61347-2-13 EN 61547 VDE 0710-T14

Reference	FUSDC-15-12T-TCI
Power	20W
Output current	12V DC
Input voltage	220 - 240V
Frequency	50/60Hz
ta °C	-25 + 55
tc °C	80
IP	20
Class	II
Norms	EN 50172 EN 55020 EN 60598-1 EN 61000-3-2 EN 61000-3-3 EN 61347-1 EN 61347-2-13 EN 61547 EN 62384 VDE 0710-T14



Emergency Kit

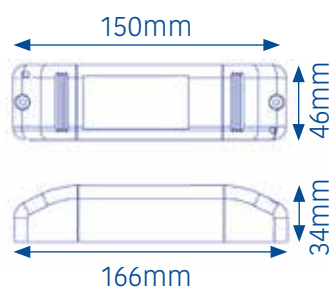

Reference	KE-1H-7W-TCI
Power	7W
Input voltage	220 - 240V
Output voltage	7,2V - 1,6Ah
Frequency	50/60Hz
ta °C	0 + 60
tc °C	80
IP	20
Class	II
Norms	EN 50172 EN 55015 EN 61000-3-2 EN 61000-3-3 EN 61347-1 EN 61347-2-13 EN 61547 VDE 0710-T14

Reference	KE-3H-7W-TCI
Power	7W
Input voltage	220 - 240V
Output voltage	7,2V - 4Ah
Frequency	50/60Hz
ta °C	0 + 55
tc °C	80
IP	20
Class	II
Norms	EN 50172 EN 55015 EN 60598-1 EN 61000-3-2 EN 61000-3-3 EN 61347-1 EN 61347-2-13 EN 61547 EN 62384 VDE 0710-T14

90 minutes emergency operation for 12 hours charge.

 Indicates the compliance with the low voltage and electromagnetic compatibility
Indique la conformité à la basse tension et compatibilité électromagnétique

 European RoHS Directive 2002/95
Directive européenne RoHS 2002/95

 Do not eliminate with the domestic wastes.
Ne pas éliminer avec les déchets domestiques.

 Company adhered to ECOEMBES
Société adhérente à ECOEMBES

 Minimum safety distance between the lighting fixture and the lightened objects
Distance de sécurité minimale entre le luminaire et les objets éclairés

 Luminaires not suitable for direct surface mounting normally flammable
Luminaires non adaptés au montage en surface direct normalement inflammable

 Compatible bulb diameter
Diamètre de l'ampoule compatible

 Maximum power of the lamp
Puissance maximale de la lampe

 Has a protective earth. Class I protection
Avec prise de terre. Catégorie de protection I

 Class II protection
Classe de protection II

 Reaction time bulb
Temps de réaction des ampoules
0,5s-100%

 No curly current
Pas de courant bouclé

 Ingress Protection Marking against dust (X) and water (Y)
Indice de protection contre la poussière (X) et l'eau (Y)

 Luminaire with UGR <19.
Luminaire avec UGR <19.

 Shock resistance. Impact energy 5 Joules
Résistance au choc. Énergie d'impact 5 Joules

 Shock resistance. Impact energy 2 Joules
Résistance au choc. Énergie d'impact 2 Joules

 No curly current
Pas de courant bouclé

 Combined lighting
Éclairage combiné

 Dimmable.
Dimmable.



Ángel Aparicio
SPAIN

Ángel Aparicio SPAIN

Cristalrecord S.L.U
Pol. Ruiseñores I Ctra. de Logroño, Km. 8,5
50011 Zaragoza. Spain
Tel. +34 976 459 277 Fax +34 976 459 278

www.cristalrecord.com

